

Since 1968

COMMAX
SmartHome & Security

User Manual

Door camera DRC-41UN



www.commax.com

COMMAX Co.,Ltd.



- Thank you for purchasing COMMAX products.
- Please carefully read this User's Guide (in particular, precautions for safety) before using a product and follow instructions to use a product exactly.
- The company is not responsible for any safety accidents caused by abnormal operation of the product.

1. Overview

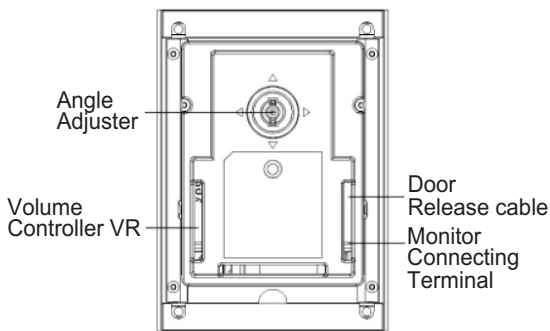
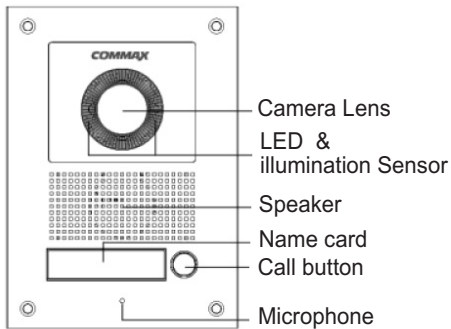

2. Installation & Wiring

► Installation

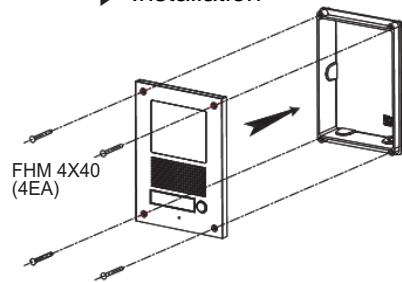

- ① Line up the holes of wall and flush box and fix it on the wall.
- ② Do the monitor wiring considering the polarity according to the image (Wiring diagram)
- ③ Fit the product from the above and press it against the bracket. Then, check the monitor screen, if it shows the place that you would like to see.
- ④ Fix it from the bottom with the screw

► Wiring

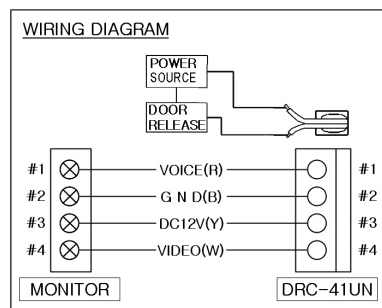

► Position of camera

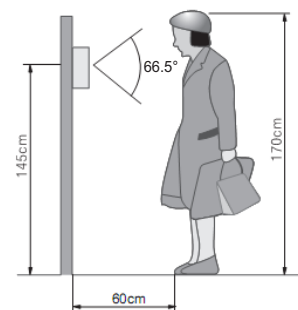

3. Package

4. Specification



Door Camera

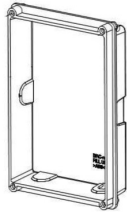

Flush box

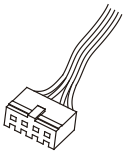

Connector
(4PX200)



Manual



Screw(4EA)
FHM(LENCH) 4X40

Model	DRC-41UN				
Power source	12V (from Monitor)				
Wiring	4wires(Polariry)C				
Camera Module	1/3 Inch C-MOS(COLOR)				
Communication	Duplex				
Frequency	PAL STANDARD				
Min. Lux.	0.1Lux(300mm from camera)				
Light	LED (Operation in Dark)				
Camera Angle	Horizontal 82°, Vertical 66.5°				
Angle Adjustment	Up, Down, Left, Right, 10° each				
Temperation	-10°C(tested up to -40°C) ~ +50°C				
Dimesion(mm)	130(W) X 182(H) X 39(D)				
Distance(TIV Cable)	Diameter(pie)	0.5	0.65	0.8	1
	Distance(M)	28	50	70	115



COMMAX Co.,Ltd.

513-11, Sangdaewon-dong, Jungwon-gu, Seongnam-si, Gyeonggi-do, Korea
Int'l Business Dept. : Tel.; +82-31-7393-540~550 Fax.; +82-31-745-2133
Web site : www.commax.com

PM1041UN0010

Printed In Korea / 2016.04.105