

*Since 1968*

**COMMAX**  
SmartHome & Security

# User Manual

User Manual DRC-40DK/41DK



[www.commax.com](http://www.commax.com)

**COMMAX Co.,Ltd.**



- Thank you for purchasing COMMAX products.
- Please carefully read this User's Guide (in particular, precautions for safety) before using a product and follow instructions to use a product exactly.
- The company is not responsible for any safety accidents caused by abnormal operation of the product.



# Contents

Safety Warning & Caution	2
1. Overview	4
2. How to use	4
3. Wiring Diagram	10
4. Installation	11
5. Package	11
6. Specification	12



# Safety Warning & Caution

Please follow the things described below in order to prevent any danger or property damage.



## Warning

It may cause a serious damage or injury if violated.



## Caution

It may cause a minor damage or injury if violated.



Prohibition.



No disassembly



No touch



Must follow strictly.



Shows plugging out the power cord without an exception



Shows the warning and caution for an electric shock.



Shows the warning and caution for a fire.



## Warning

### Power & Installation

Please don't use several products at the same time on one power socket.

- It may cause a fire due to an abnormal overheating.

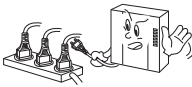

Prohibition Fire

Please don't bend the power cable excessively or it may cause an electric shock.

- fire when using a damaged power cable.

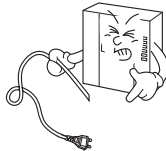

Prohibition Electric shock Fire

Please don't handle the power cable with a wet hand.

- It may cause an electric shock.

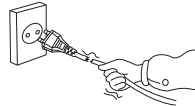

Prohibition Fire

Please plug out the power cable from the socket when not using it for a long period of time.

- It may shorten the product lifespan or cause a fire.

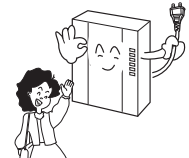

Request Fire

Please don't install the product in the place where there is much oil, smoke or humidity.

- It may cause an electric shock or fire.

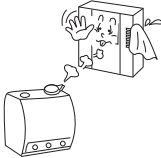

Prohibition Electric shock Fire

Please don't install the product with the lightning and thunder.

- It may cause an electric shock or fire.

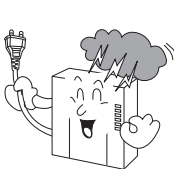

Prohibition Electric shock Fire

Please don't use and connect this product with other products with different rated voltage.

- It may cause a disorder or fire.



Prohibition Fire

When installing the product that generates heat, please install the product away from the wall (10cm) for the ventilation.

- It may cause a fire due to the increased internal temperature.

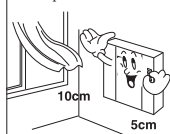

Prohibition Fire

## ⚠ Warning

### Cleaning & Use

Please don't disassemble, repair or rebuild this product arbitrarily (please contact the service center if a repair is needed).

- It may cause an electric shock or fire.

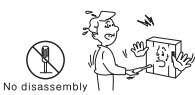

If an abnormal sound, burning smell or smoke is coming out of the product, please plug out the power cable and contact a service center.

- It may cause an electric shock or fire.

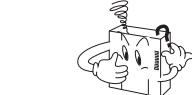

Please don't insert any metallic or burnable materials into the ventilation hole.

- It may cause an electric shock or fire.

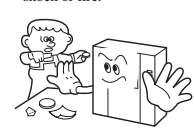

Please use only the designated batteries for the products of using DC power.

- It may cause an electric shock or fire.

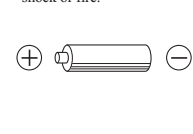

## ⚠ Caution

### Power & Installation

Please plug the power cable firmly into the inner end.

- It may cause a fire.



Please hold the plug tightly when unplugging the power cable (a part of the copper wire may be disconnected if the grabbing is only made on the cord when pulling out the cable).

- It may cause an electric shock or fire.



When connecting the power cables after cutting the cable, please install the product with power off.

- It may cause an electric shock or fire.

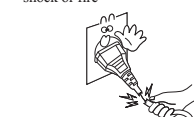

When installing the product, please fix it firmly while using the wall-mounting unit and screws.

- It may cause an injury from the falling object.

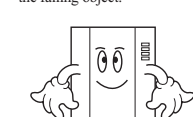

Please be careful when using an AC circuit breaker since there is a possibility of an electric shock.



Please check the use voltage and current for the DC-only products and use the appropriate rectifier.

- It may cause a fire.



Please avoid direct rays of the sun or heating devices at a time of installation.

- It may cause a fire.

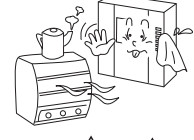

Please don't install the product on an unstable place or small support board.

- It may cause an injury if it falls down while in use.

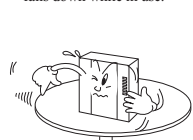

### Cleaning & Use

When cleaning the product, please rub it with a soft and dry cloth after plugging out the power cable. (Please don't use any chemical products such as wax, benzene, alcohol or cleanser.)



Please don't drop the product on the ground and don't apply a shock.

- It may cause a failure.

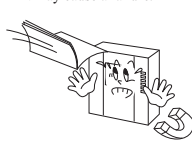

Please use the designated connection cable within the maximum calling distance designated for the product.

- It may reduce the product performance.





# 1. Overview

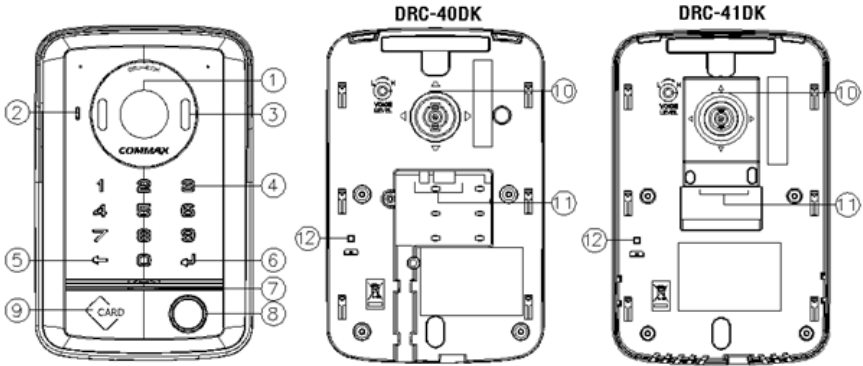

No.	contents	No.	contents
1	Camera	6	Enter button
2	Microphone	7	Speaker
3	White LED & Illuminance sensor	8	Call button
4	Keypad button	9	RF Card Tag
5	Back/Cancel button	10	Camera angle adjustment
11	Connecting port/ WIRE for door realease	12	Anti-theft switch



# 2. How to use



## \* Default behavior

- This product uses DC 12V / 1A adapter (RF-1A recommended, sold separately).
- If the power supply from the adapter is poor (disconnection or malfunction), the power supplied from the monitor can be used as an emergency power source.

## <Notes when using emergency power>

- 1) The emergency power source is supplied from monitor for 30 seconds when the monitor is called by the camera.
- 2) In this case, some functions may cause difference from normal operation.  
(Required function such as door opening is normal.)
- 3) Emergency power may not be used if wiring is poor or the distance is too long.

\* Button description

Image	Description
	Back, Cancel ⑤ (C : Cancel) Use this button to cancel the function.
	OK Button ⑥ (E : Enter) Use this button for setting and execution.

\* Anti-theft alarm function ⑫

- To prevent the device from being stolen, the alarm sounds when removed from the wall. However, the alarm sounds only when power is supplied to the unit.
- To enhance security function, the automatic call is sent to monitor call as the alarm occurs. The automatic call operates at all time when removed from the wall, regardless of power supply status.

\* Reset password

- If you forget your password, you can reset it as follows.

1) With the monitor, enter the door camera monitoring function.

Try to press door opening button 7 times quickly within 20 seconds.

2) Then, LED of the camera is blinking and push OK Button ( E ) for 3 seconds to reset password.

## 2-2. Set the functions

<Required>

1) The initial password is 1.2.3.4. Be sure to change the initial password before use.

2) 0000, 1234, 4321 can not be set as a password.

3) Password can be set from 4 to 12 digits.

(The password out of this range is not available)

## 2-2-1. Password setting

### 1) Password registration / change



- ① Press program number (0) and press OK button (E)
- ② Enter the existing password (Initial: 1, 2, 3, 4) and press the OK button (E)
- ③ If the password change mode is successfully entered, the KEY LED will blink.
- ④ Click the new password to be changed.
- ⑤ Press the OK button (E), the key LED stops blinking and the setting is completed.

### 2) RF card registration

- Up to 1,024 cards can be registered.

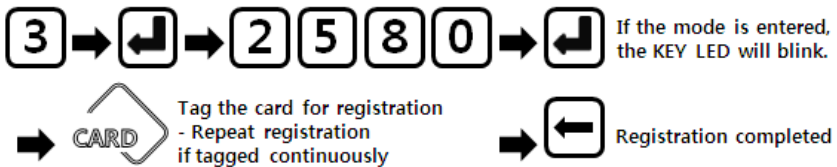

- ① Press program number (3) and press OK button (E)
- ② Enter the password and press the OK button (E).
- ③ When the RF card registration mode is successfully entered, the KEY LED will blink.
- ④ Tag the card to be registered to the RF receiver.  
If you tag another card continuously, you can register all the cards at once.
- ⑤ Press the Cancel button (C) and the KEY LED stops blinking and registration is completed.

### 3) Delete individual RF cards

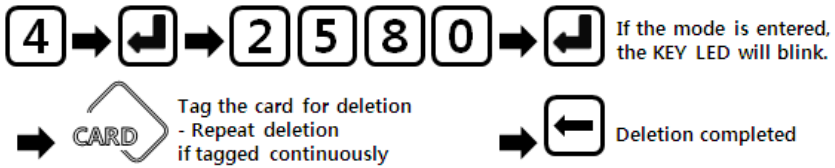

- ① Press program number (4) and press OK button (E)
- ② Enter the password and press the OK button (E).
- ③ When individual deletion mode is successfully entered, the KEY LED will blink.
- ④ Tag the card to be deleted to the RF receiver.  
If you tag another card continuously, you can delete multiple cards at once.
- ⑤ Press the Cancel button (C) and the KEY LED stops blinking and individual deletion is completed.

### 4) Delete all RF cards



- ① Press program number (5) and press OK button (E)
- ② Enter the password and press the OK button (E).
- ③ When all deletion mode is successfully entered, the KEY LED will blink.
- ④ Press and hold the OK button (E) for 2 seconds, the whole deletion will proceed with the beep sound.
- ⑤ When the whole deletion is completed, beep sound and KEY LED will stop..



## 5) Door opening with password

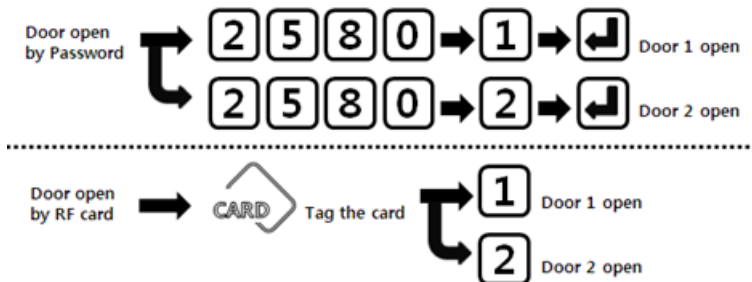

### - Door open by Password

- ① After entering the password, press the door number you want to open and then press OK button (E).  
ex) When opening door # 1: 2580 -> 1 -> OK button (E)

### - Door open by RF card

- ① After tagging RF card to the RF receiver, press the door number you want to open  
ex) When opening door number 1: Card tag -> 1
- ② When the door is opened successfully, the operation is completed with the beep sound.

## 6) Communication Volume adjustment



- ① Press program number (6) and press OK button (E)
- ② Enter the password and press the OK button (E).
- ③ When the call volume control mode is successfully entered, the KEY LED will blink.
- ④ The volume of communication can be adjusted from level 1 to 3.  
(Enter the number between 1~3.)
- ⑤ After enter the level number, press the OK button (E) and the key LED stops blinking and the setting is completed. When completed, beep sound is heard as the number of level.

7) Beep(Touch and so on) Volume adjustment



- ① Press program number (7) and press OK button (E)
- ② Enter the password and press the OK button (E).
- ③ When the beep volume control mode is successfully entered, the KEY LED will blink.
- ④ The beep volume can be adjusted from level 1 to 2.  
(Enter the number between 1~2.)
- ⑤ After enter the level number, press the OK button (E) and the key LED stops blinking and the setting is completed. When completed, beep sound is heard as the number of level.

<Notes>  
1) Even if the beep volume is adjusted, during Calling and Communication mode, it is fixed in level 1 to maintain Communication quality  
(It cannot be adjust the beep volume during Calling and Communication mode)

8) ON/OFF Anti-theft switch



- ① Press program number (8) and press OK button (E)
- ② Enter the password and press the OK button (E).
- ③ When anti-theft setting mode is successfully entered, the KEY LED will blink.
- ④ Anti-theft function OFF : Enter 0  
Anti-theft function ON : Enter 1
- ⑤ Press the OK button (E) as key LED stops blinking and the setting is completed.

<Notes>  
1) After installing the unit on the wall, turn on the anti-theft switch.  
2) If the unit is detached from the wall, an alarm occurs.  
In this case, the alarm will stop 10 seconds after the unit is re-attached to the wall.  
The alarm can be turned off with above program (8) while alarm rings.

### 9) Touch LED setting



- ① Press program number (9) and press OK button (E)
- ② Enter the password and press the OK button (E).
- ③ If touch LED setting mode is successfully entered, the KEY LED will blink.
- ④ LED ON only when the key touched: Input 0  
 LED ON every time with power supplied: Input 1
- ⑤ After entering the number, press the OK button (E) and the key LED stops blinking and the setting is completed.

## 3. Wiring Diagram

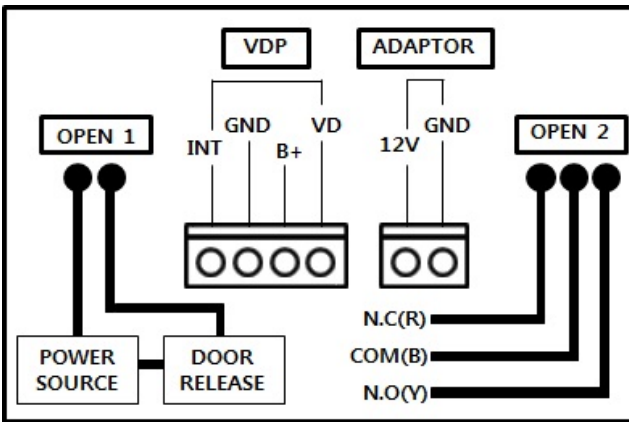

#### \* Precautions

- When wiring the household monitor, connect as follows.  
 Failure to do the wiring as shown below may cause the video / audio noise.

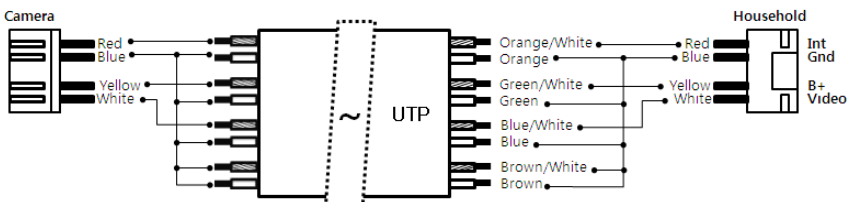



## 4. Installation

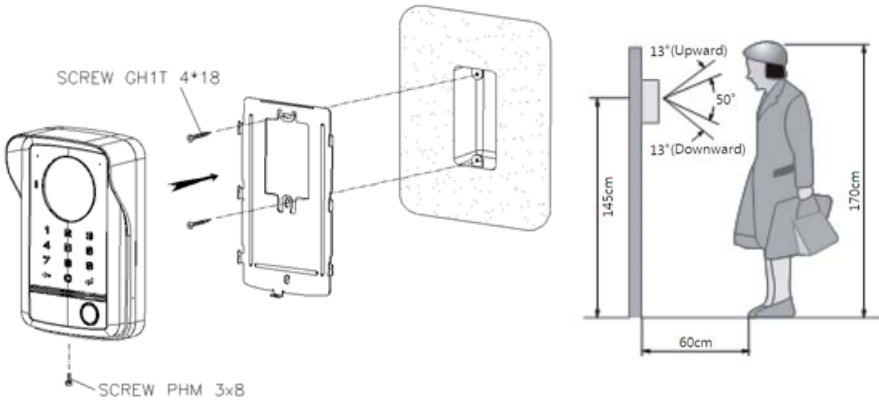

## 5. Package

Item	Description	Qty
CONN. 4Px300	4 wire connector	1
CONN. 2Px300	2 wire connector	1
Bracket	Bracket for installation	1
Screw GH1T 4x18	Bracket screw	2
Screw PHM 3x8	Bracket + Monitor	1
User Manual	English version manual	1



## 6. Specification

Model	DRC-40DK/41DK
Power	12VDC/1A (Adaptor)
	12VDC (emergency power from monitor)
Communication	Duplex communication
Min. illumination	0.1Lux (up to 300mm from camera / with normal LED operation)
Illumination	White LED equipped (night vision)
Image sensor	CMOS IMAGE SENSOR (0.52 megapixels)
Imaging angle	93° horizontal, 50° vertical, 110° diagonal
Adjustable angle	13° (pan and tilt)
RF Module	13.56MHz
Operation temp.	-10℃ (tested up to -40℃) ~ +50℃
Dimension (mm)	DRC-40DK : 127(W)x193(H)x54(D), DRC-41DK : 127(W)x193(H)x63(D)
Distance	28 meters (Φ 0.5 UTP), It must be observed.
	Resistance under 10 Ω per 100 meters on UTP Cat 5e.

**<Caution>**

We recommend the COMMAX adaptor.

We are not responsible for problem caused by the use of adaptors of other company.

# **COMMAX**

**COMMAX Co.,Ltd.**

513-11, Sangdaewon-dong, Jungwon-gu, Seongnam-si, Gyeonggi-do, Korea

Int'l Business Dept. Tel. : +82-31-7393-540~550 Fax. : +82-31-745-2133

Web site : [www.commax.com](http://www.commax.com)

PM0743KM0010

Printed In Korea / 2016.04.104