

Since 1968

Home Network
COMMAX

User Manual

Door Phone DP-4VHP



www.commax.com

COMMAX Co.,Ltd.



- Thank you for purchasing COMMAX products.
- Please carefully read this User's Guide (in particular, precautions for safety) before using a product and follow instructions to use a product exactly.
- The company is not responsible for any safety accidents caused by abnormal operation of the product.



Table of Contents

Warnings and caution	2
1. General Function	4
2. Installation	4
3. Wiring diagram.	5
4. Contents	5
5. Specification.	6

Warnings and caution

Please follow the things described below in order to prevent any danger or property damage.

	<p>Warning It may cause a serious damage or injury if violated.</p>		<p>Prohibition.</p>
	<p>Caution It may cause a minor damage or injury if violated.</p>		<p>No disassembly</p>
			<p>No touch</p>
			<p>Must follow strictly.</p>
			<p>Shows plugging out the power cord without an exception</p>
			<p>Shows the warning and caution for an electric shock.</p>
			<p>Shows the warning and caution for a fire.</p>

Warning

Power & Installation

Please don't use several products at the same time on one power socket.

- It may cause a fire due to an abnormal overheating.

Please don't bend the power cable excessively or it may cause an electric shock.

- fire when using a damaged power cable.

Please don't handle the power cable with a wet hand.

- It may cause an electric shock.

Please plug out the power cable from the socket when not using it for a long period of time.

- It may shorten the product lifespan or cause a fire.

Please don't install the product in the place where there is much oil, smoke or humidity.

- It may cause an electric shock or fire.

Please don't install the product with the lightning and thunder.

- It may cause an electric shock or fire.

Please don't use and connect this product with other products with different rated voltage.







- It may cause a disorder or fire.

When installing the product that generates heat, please install the product away from the wall (10cm) for the ventilation.

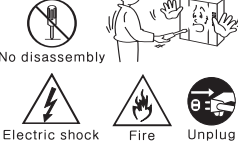
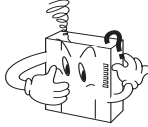

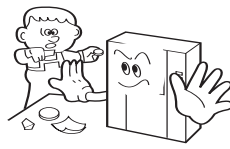







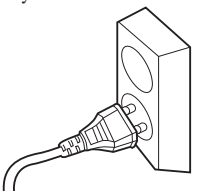

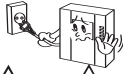

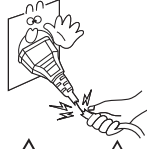

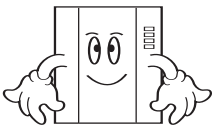

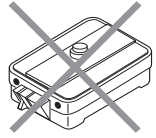

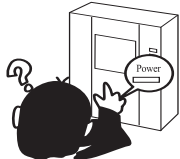

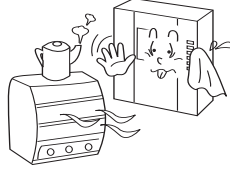
- It may cause a fire due to the increased internal temperature.

Warnings and caution

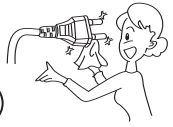
Warning

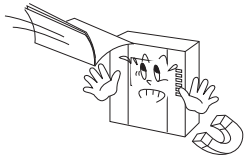
Cleaning & Use	<p>Please don't disassemble, repair or rebuild this product arbitrarily (please contact the service center if a repair is needed).</p> <ul style="list-style-type: none"> · It may cause an electric shock or fire.  <p>No disassembly</p> 	<p>If an abnormal sound, burning smell or smoke is coming out of the product, please plug out the power cable and contact a service center.</p> <ul style="list-style-type: none"> · It may cause an electric shock or fire.  	<p>Please don't insert any metallic or burnable materials into the ventilation hole.</p> <ul style="list-style-type: none"> · It may cause an electric shock or fire.  	<p>Please use only the designated batteries for the products of using DC power.</p> <ul style="list-style-type: none"> · It may cause an electric shock or fire.  
---------------------------	--	---	--	---

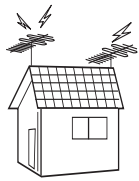
Caution

Power & Installation	<p>Please plug the power cable firmly into the inner end</p> <ul style="list-style-type: none"> · It may cause a fire.  	<p>Please hold the plug tightly when unplugging the power cable (a part of the copper wire may be disconnected if the grabbing is only made on the cord when pulling out the cable).</p> <ul style="list-style-type: none"> · It may cause an electric shock or fire  	<p>When connecting the power cables after cutting the cable, please install the product with power off</p> <ul style="list-style-type: none"> · It may cause an electric shock or fire  	<p>When installing the product, please fix it firmly while using the wall-mounting unit and screws.</p> <ul style="list-style-type: none"> · It may cause an injury from the falling object.  
	<p>Please be careful when using an AC circuit breaker since there is a possibility of an electric shock.</p>  	<p>Please check the use voltage and current for the DC-only products and use the appropriate rectifier.</p> <ul style="list-style-type: none"> · It may cause a fire.  	<p>Please avoid direct rays of the sun or heating devices at a time of installation.</p> <ul style="list-style-type: none"> · It may cause a fire.  	<p>Please don't install the product on an unstable place or small support board.</p> <ul style="list-style-type: none"> · It may cause an injury if it falls down while in use.  
	<p>When cleaning the product, please rub it with a soft and dry cloth after plugging out the power cable. (Please don't use any chemical products such as wax, benzene, alcohol or cleanser.)</p>  	<p>Please don't drop the product on the ground and don't apply a shock.</p> <ul style="list-style-type: none"> · It may cause a failure.  	<p>Please use the designated connection cable within the maximum calling distance designated for the product</p> <ul style="list-style-type: none"> · It may reduce the product performance.  	



1. General Function

1. Call a DP-4VHP from common entrance

- a) Ring a chime sound.
- b) Pick up a handset to talk.
- c) While on the phone, press door release button to open the door.
- d) Leave the handset to end the talk.

2. Call a DP-4VHP from Master Unit

- a) Ring a chime sound.
- b) Pick up a handset to talk.

3. Call a Master from DP-4VHP

- a) Press the “ Call” button on DP-4VHP continuously.
- b) Once a Master receives a call, then your call is on the line. During the conversation, in case there is call from the entrance, then all three parties can talk each other.



2. Installation

◆ Installation Diagram

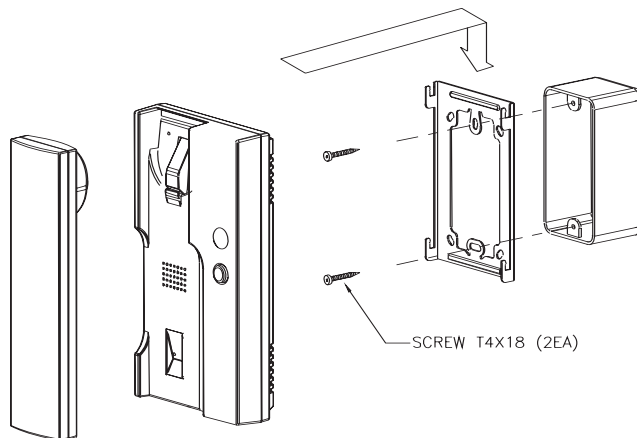

* Caution

- Please avoid direct ray of sun light to install this unit.
- 1450~1500mm is right height from the floor.
- Please avoid the place where being affected by gas, magnetic source and humid.



3. Wiring diagram

◆ Wiring

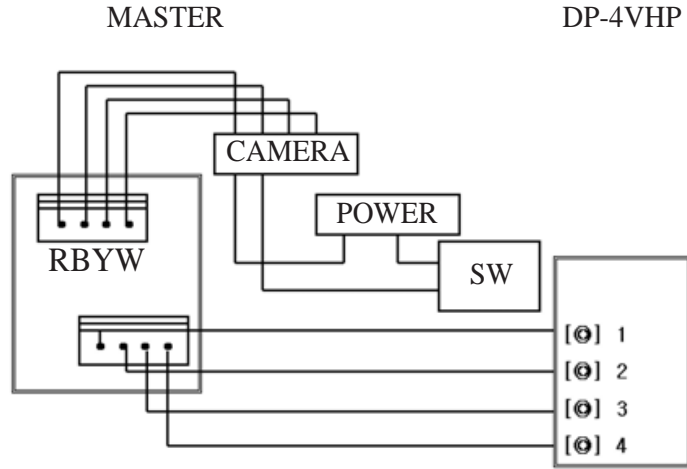

* Warning

1. In case of installation around the area where pass the high-voltage line, please use metal tube with coaxial cable.
2. Any malfunction or abnormal operation shall be caused by scar or peel off the wire.



4. Contents

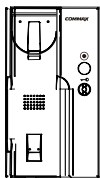

Body

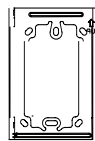

Wall bracket



Manual



Handset



screw
T4X18(2EA)

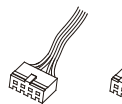

4P connector(1EA)



5. Specification

Model	DP-4VHP
Power Voltage	220V~, 50/60Hz
Power Consumption	MAX : 4 W (220V/60Hz)
Transmission	To Master unit : 4wires
Communication Method	Handset
Sound	From Outdoor unit : Electronic Chime
Time	60 ± 20sec
Distance	28m(∅ 0.5) / 50m(∅ 0.65) / 70m(∅ 0.8)
Operating Temperature	0 ~ +50°C
Weight	0.55 kg
Dimension	107(W)X195(H)X52(D) mm

COMMAX

COMMAX Co.,Ltd.

513-11, Sangdaewon-dong, Jungwon-gu, Seongnam-si, Gyeonggi-do, Korea

Int'l Business Dept. Tel. : +82-31-7393-540~550 Fax. : +82-31-745-2133

Web site : www.commax.com

Printed In Korea / 2011.01.103