

Since 1968

COMMAX
SmartHome & Security

User Manual

Color Video Door Phone CMV-43S

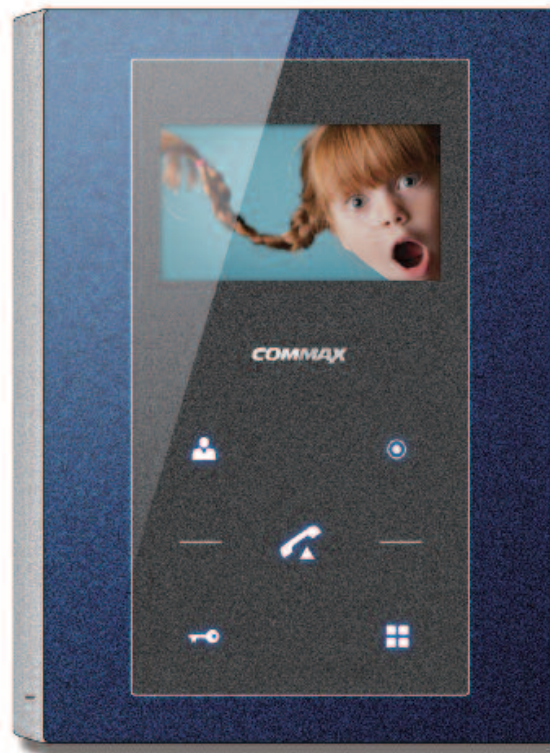

www.commax.com

COMMAX Co.,Ltd.



- Thank you for purchasing COMMAX products.
- Please carefully read this User's Guide (in particular, precautions for safety) before using a product and follow instructions to use a product exactly.
- The company is not responsible for any safety accidents caused by abnormal operation of the product.



Table of Contents

1. Greetings	1
2. Warnings and Cautions.....	2
3. Part names.....	4
4. Operation	5
5. Settings	10
6. Initialization	12
7. Installation	12
8. Wiring Diagram.	14
9. Product components	16
10. Specifications.....	17
11. Safe Operation guide	17



1. Greetings

- Thank you for Purchasing COMMAX Products
- Please carefully read this User's Manual (in particular, precautions for safety) before using a product and follow instructions to use a product exactly.



2. Warnings and cautions

Please follow the things described below in order to prevent any danger or property damage.

	Warning	It may cause a serious damage or injury if violated.		Prohibition.
	Caution	It may cause a minor damage or injury if violated.		No disassembly
				No touch
				Must follow strictly.
				Shows plugging out the power cord without an exception
				Shows the warning and caution for an electric shock.
				Shows the warning and caution for a fire.

Warning

Power & Installation

Please don't use several products at the same time on one power socket.

- It may cause a fire due to an abnormal overheating.

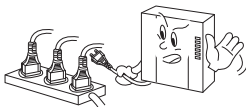

Please don't bend the power cable excessively or it may cause an electric shock.

- fire when using a damaged power cable.

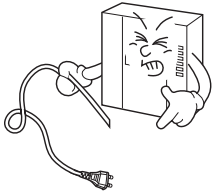

Please don't handle the power cable with a wet hand.

- It may cause an electric shock.

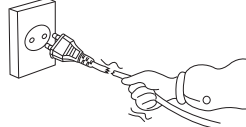

Please plug out the power cable from the socket when not using it for a long period of time.

- It may shorten the product lifespan or cause a fire.

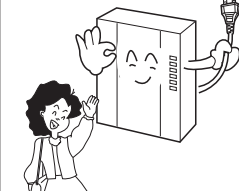

Please don't install the product in the place where there is much oil, smoke or humidity.

- It may cause an electric shock or fire.

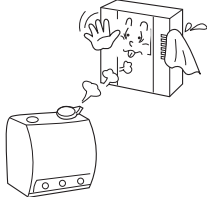

Please don't install the product with the lightning and thunder.

- It may cause an electric shock or fire.

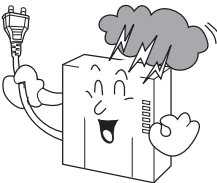

Please don't use and connect this product with other products with different rated voltage.

- It may cause a disorder or fire.

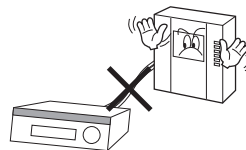

When installing the product that generates heat, please install the product away from the wall (10cm) for the ventilation.

- It may cause a fire due to the increased internal temperature.

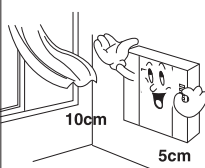

! Warning

Cleaning & Use

Please don't disassemble, repair or rebuild this product arbitrarily (please contact the service center if a repair is needed).

- It may cause an electric shock or fire.



No disassembly



Electric shock Fire Unplug

If an abnormal sound, burning smell or smoke is coming out of the product, please plug out the power cable and contact a service center.

- It may cause an electric shock or fire.

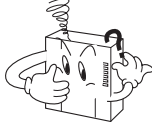

Electric shock Fire

Please don't insert any metallic or burnable materials into the ventilation hole.

- It may cause an electric shock or fire.

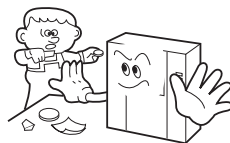

Prohibition Electric shock Fire

Please use only the designated batteries for the products of using DC power.

- It may cause an electric shock or fire.



Request

! Caution

Power & Installation

Please plug the power cable firmly into the inner end

- It may cause a fire.

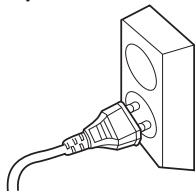

Request Fire

Please hold the plug tightly when unplugging the power cable (a part of the copper wire may be disconnected if the grabbing is only made on the cord when pulling out the cable).

- It may cause an electric shock or fire.



Request Electric shock Fire

When connecting the power cables after cutting the cable, please install the product with power off

- It may cause an electric shock or fire.

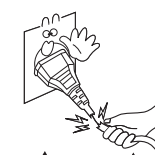

Request Electric shock Fire

When installing the product, please fix it firmly while using the wall-mounting unit and screws.

- It may cause an injury from the falling object.

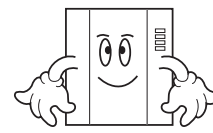

Request

Please be careful when using an AC circuit breaker since there is a possibility of an electric shock.

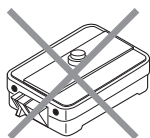

Request Electric shock

Please check the use voltage and current for the DC-only products and use the appropriate rectifier.

- It may cause a fire.



Request Fire

Please avoid direct rays of the sun or heating devices at a time of installation.

- It may cause a fire.

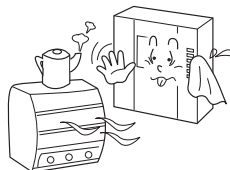

Request Overheating Fire

Please don't install the product on an unstable place or small support board.

- It may cause an injury if it falls down while in use.

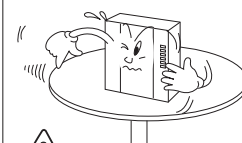

Request

Cleaning & Use

When cleaning the product, please rub it with a soft and dry cloth after plugging out the power cable. (Please don't use any chemical products such as wax, benzene, alcohol or cleanser.)



Prohibition

Please don't drop the product on the ground and don't apply a shock.

- It may cause a failure.

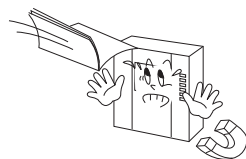

Prohibition

Please use the designated connection cable within the maximum calling distance designated for the product

- It may reduce the product performance.

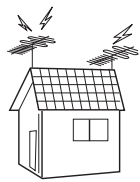

Request



3. Part names

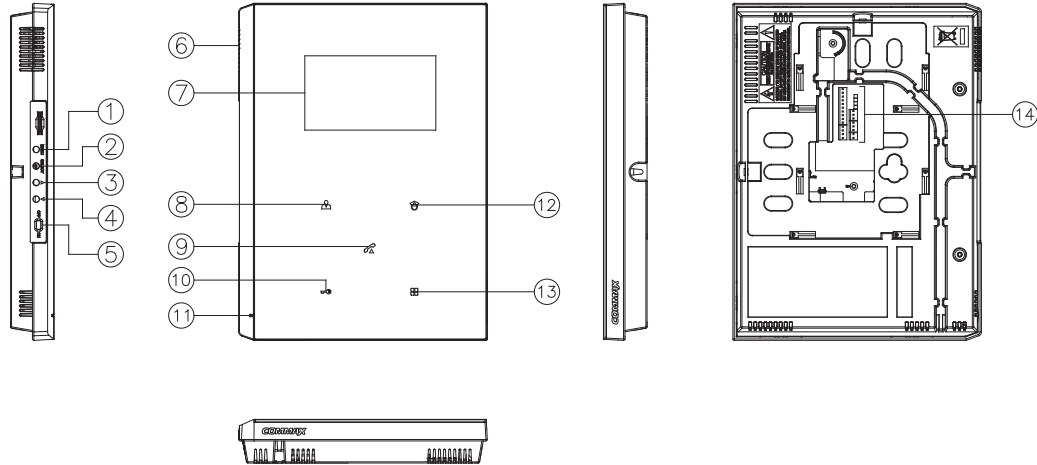

No.	Part name	No.	Part name	No.	Part name
1	Menu button(side)	2	Enter button	3	△ button
4	▽ button	5	Power ON/OFF	6	Speaker
7	4.3" TFT LCD	8	Monitoring button	9	Talk button
10	Door release button	11	C-MIC	12	Guard and interphone button
13	Menu button(touch)	14	Connecting terminals		



4. Operation

4-1 Functions for single & MODUM system

4-1-1 Use for single system

1) Communicate with visitor

(1) Communicate in Monitor

- ① As the paging button on a door camera is pressed, the paging tone rings at the connected videophone and the visitor's figure appears on the monitor.
- ② Press "Call" button to talk to the visitor and "Door release" button to open the door. (The door release function is enabled only when the screen is turned on and the individual door camera has door release terminal)
- ③ If another visitor calls from another entrance during a call, the first call is automatically ended and the connection to another entrance is made.
- ④ Press the "Call" button to finish the communication and convert to the standby mode.

(2) Communicate with additional interphone

- ① As the paging button on a door camera is pressed, the paging tone rings at the interphone and videophone at the same time.
- ② Pick up the hand-set to start talking with a visitor, and to release the door for pressing HOOK switch or Door release button. (The door release function is enabled only when the screen is turned on and the individual door camera has door release terminal).
- ③ Visitor, interphone and monitor can communicate at the same time if press the "Call" button of monitor.
- ④ Hang off the hand-set to finish the call and convert to standby mode.

2) Communication between the monitor and interphone

(1) Monitor → Interphone

- ① Press the "Guard and interphone" button in the monitor, the paging tone rings at the interphone.
- ② Pick up the handset to start communicating with interphone.
- ③ Press "Call" button to finish the communication and convert to standby mode.

(2) Interphone → Monitor

- ① Pick up the hand-set and press the "Call" button, the paging tone rings at the monitor.
- ② Press "Call" button on the monitor to start communicating.
- ③ Hang off the hand-set to finish the communication and convert to standby mode.

3) Monitoring

- ① Press the “Monitoring button” in standby mode, you can check the image in order.
 - Camera 1 → Camera 2 → OFF → Camera 1 → repeat
- ② Press “Call” button during monitoring to call to the entrance.

4-1-2 Use for MODUM system

- This function is only for MODUM system.
- If the MODUM system is connected, it is automatically recognized when it boot.
Please reboot the power after installation for stable operation.
- Enter the OSD menu, OSD will be arranged in order as same as front touch key buttons

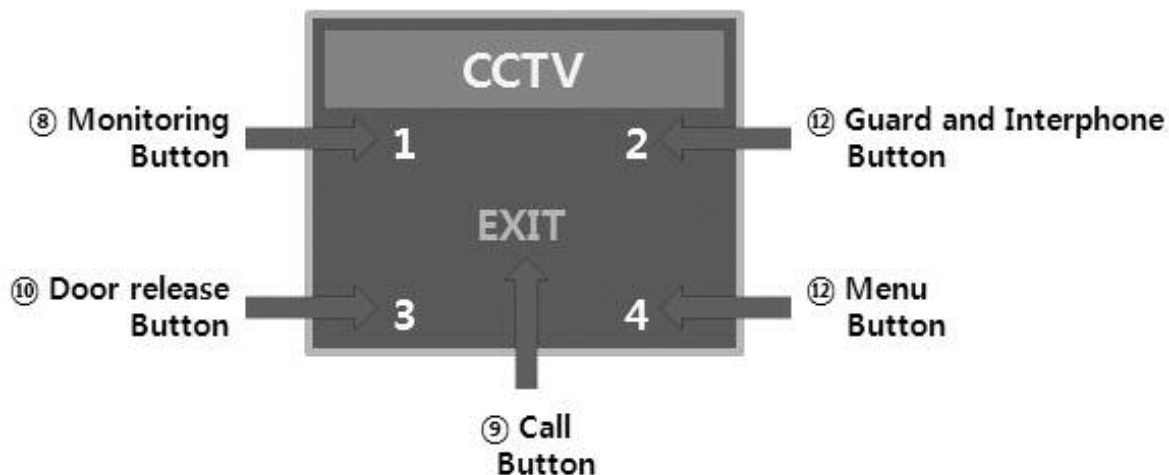

1) Communicate with visitor

- (1) Communicate in monitor
 - (a) Paging from a common entrance
 - ① When a visitor page from a common entrance, the paging tone rings and the visitor's figure appears on the monitor.
 - ② Press “Call” button to talk to the visitor and “Door release” button to open the door.
(The door release function is enabled only when the screen is turned on.)
 - ③ If another visitors calls from an individual entrance, the paging tone rings and press “Monitoring” button to receive a call from the individual entrance after finishing the communication with a common entrance.
 - ④ Press “Call” button to finish the call and convert to standby mode.
 - (b) Paging from an individual entrance
 - Same as the Single system mode.(Except interphone related information)

- The paging tone rings when it is received a paging from a common entrance or guard station while talking with the individual entrance. Press “Guard and interphone” button to connect after finishing communication with the individual door unit.

2) Communication with a guard

(1) Receive a call

- ① The paging tone rings when receive a call from guard station.
- ② Press “Call” button to communicate.
- ③ When it receive any paging from an individual door camera, the paging tone rings and press “Monitoring” button to receive a call from the individual door camera after finishing the communication with a guard station.
- ④ Press “Call” button to finish the communication and convert to standby mode.

(2) Make a call

- The following menu appears on the right-lower corner when “Guard and interphone” button is pressed in standby mode.



- For paging “Porter”, press “Monitoring” button while the menu is displayed on the screen.
: The call is connected if PORTER receives it.
- For paging “Guard”, press “Guard and interphone” button while the menu is displayed on the screen.
: The call is connected if the guard receives it.
- Press “Call” button if you don’t make a call.

3) Monitoring (Individual entrance / Common entrance / CCTV)

- The following menu will be appeared on the right-lower corner when press the “Monitoring” button in standby mode.



- Press “Monitoring” button to monitor the individual entrance when OSD menu displays on screen.
- Press “Guard and interphone” button to monitor the common entrance when OSD menu appears on screen.
: Press “Call” button to make a call while monitoring the individual and common entrance.
Press “Call” button to finish the menu.

- Press "Door release" button to monitor CCTV when OSD menu appears on screen.
: When the CCTV monitoring mode is selected, the additional select menu displays on screen. Press "Call" button to finish it. (Refer to description below to select CCTV for monitoring.)

- Additional CCTV selection menu

(1) When 1 unit of CMD-104VU is installed,

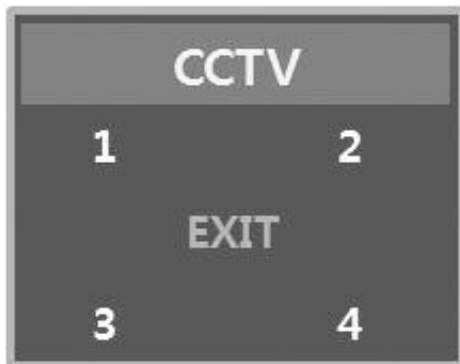

: Ports number 1 to 4 will be shown on screen and press each port number that will be displayed on the screen.

: Port number that is displayed on the screen depends on the setting of DIP S/W of CMD-104VU.

(If port number 1-2 is connected, only no. 1 and 2 will be displayed)

(2) When 2 units of CMD-104VU are installed



: The ▶ mark will be shown with port number and you can move on the next page. (Up to 8 ports, No. 1-8)

: According to ID setting of CMD-104VU, ID 1 of CMV-104VU will be connected with port No. 1 ~ 4, ID 2 of CMV-104VU will be connected with port No.5 ~ 8.

NOTE

1. You can check the other CCTV screen pressing other numbers while you are monitoring.
(If you press the same button that you have already monitored, monitoring will be finished and convert to standby mode.)
2. You can select up to 8 CCTV, and available quantities are automatically recognized and displayed on screen.

4) Page the elevator



- If the elevator is connected with monitor, you can use this function.
- In the standby mode, if you press the “Guard & Interphone” button, the additional menu will be displayed at the lower-right corner of screen.
- For paging elevator, press the door release button while the menu is displayed.
- When you page the elevator, “EVL CALL” message will be displayed at the top of screen.
- After paging the elevator, the screen will be back to the standby mode.
- If you don't page the elevator, press the “CALL” button.



5. Settings

- Press "Menu" button in video call or monitoring mode then Setting OSD will be shown on screen.
- Both front touch keys and side switches can be used for settings as below.

1) Side switches

- Start and finish menu : ① MENU button
- Move up / right : ③ △ button
- Select and input : ② SELECT button
- Move down / left : ④ ▽ button

2) Touch keys

- ⑬ Press "Menu" button then OSD will be display on right side of screen as below.
- As same as menu OSD, the front touch key buttons will be arrayed as same as OSD menu.



- (1) Move left : ⑧ MONITORING button
- (2) Move right : ⑫ GUARD and INTERPHONE button
- (3) Start menu : ⑨ CALL button
- (4) Finish : ⑬ MENU button

- OSD will be changed as below when select any menu.



- (1) Move up : ⑧ MONITORING button
- (2) Move down : ⑩ DOOR RELEASE button
- (3) Select and enter : ⑨ CALL button
- (4) Finish : ⑬ MENU button

5-1 DOOR VIDEO SET (Control the display)

- 1) BRIGHTNESS : select 0~20, defaults 10
 - 2) CONTRAST : select 0~20, defaults 10
 - 3) COLOR : select 0~20, defaults 10
- Settings for Brightness / Contrast / Color
 - (1) Use "Move" key to go to the each section

- (2) Press "Select" key to activate the section(Move to the select window)
- (3) Use "Move" key to adjust the level from 0 to 20.
- (4) After adjustment, press "Select" key to go back to menu.
- 4) RESET : Reset Brightness / Contrast / Color.
Press "Select" key and select YES. And then press "Select" key again to reset.
- 5) EXIT : Press "Select" key to go back to setting menu

5-2 UTILITY(Set the volume and screen ratio)

- 1) CHIME-BELL VOLUME : Adjust the chime-bell volume when it receives the paging.
 - Adjust from 0(MUTE) to 3(MAX).
- 2) SPEAKER VOLUME : Adjust the speaker volume while calling.
 - Adjust from 1(MIN) to 3(MAX).
- 3) CHIME-RECALL MODE : Sets the count of chime-bell.
 - SINGLE : 1 time / REPEAT : Continually
- 4) EXIT : Press "Select" key to go back to setting menu.

5-3 INFORMATION (Check product name and version)

- 1) Model : Product name
- 2) Version : Product version
- 3) HOME ID : Display the household number.
- 4) Video : Display the transmission formats (PAL / NTSC)
- 5) Source : Display the position of camera (lobby, entrance camera etc.)
- 6) Touch : Display the touch key version.

5-4 EXIT

- Using the move buttons to "Exit" menu and finish the setting.

6. Initialization

- As “Interphone” and “Door release” buttons are pressed, at the same time, more than 3 seconds in standby mode, the initialization will be progressed with “Beep-Beep-Beep” sounds.
- Please note that all information and screen mode are initialized with this progress.

7. Installation

Monitor

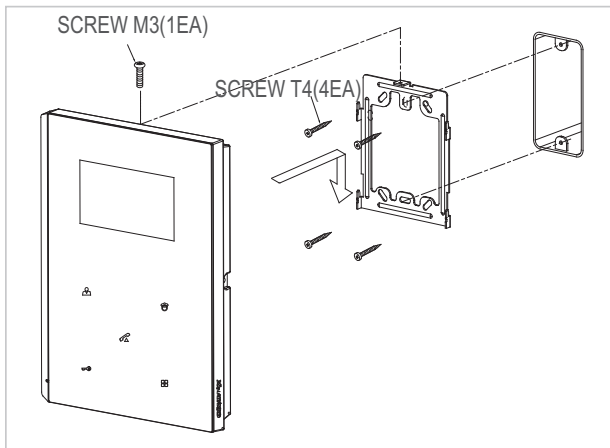

※ Note

- Avoid installing the product in the area of direct sunlight.
- The position of the unit's body should fit the standard height range (Recommended height range is 1450 ~ 1500mm.)
- Avoid installing the product exposed to gas exposure, magnetic force, in humid temperatures, as it may damage the condition and performance of the product.

▷ Camera

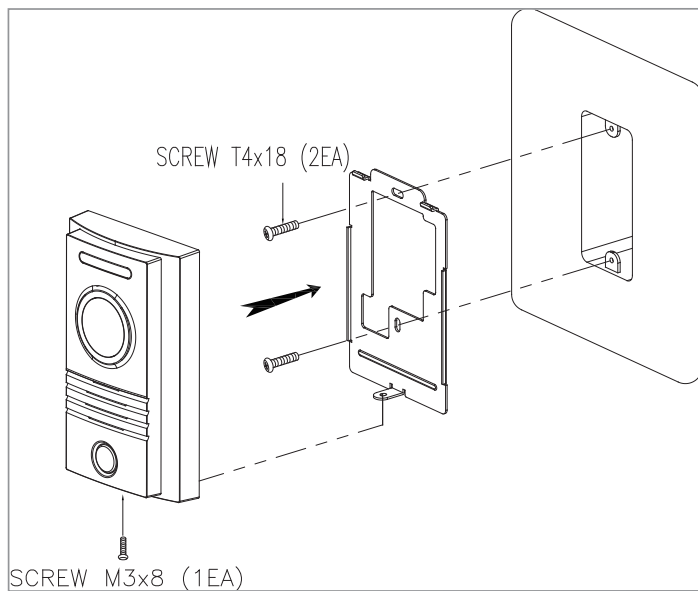

※ **Note**

- Do not install a door camera in the area exposed to direct sunlight or backlight.
- Please keep the lens clean for the clearest image reflection.



8. Wiring Diagram

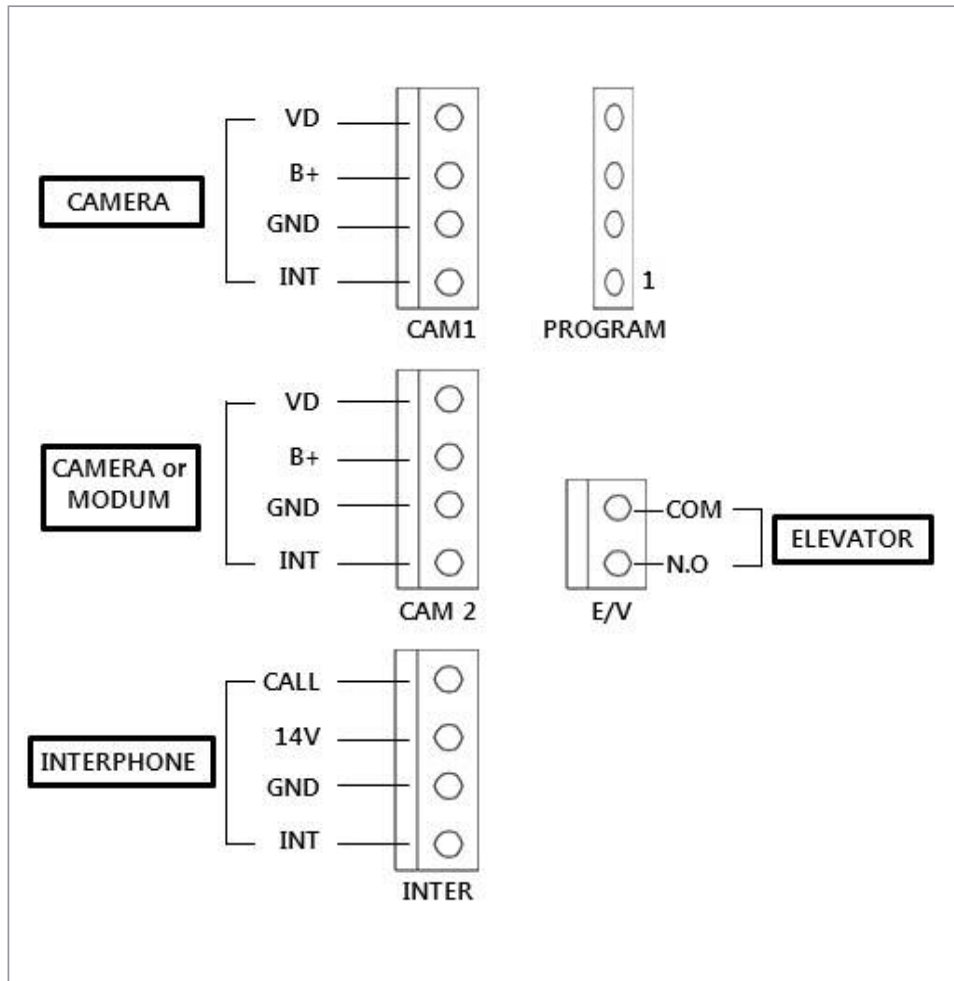

※ If you connect with MODUM system, you need to connect with 'CAMERA2' ports and floor distributor(Please refer to the manual of floor distributor for wiring.)

Warning :

- If you connect with a floor distributor(to connect with lobby or guard station), you have to connect with only 'CAMERA2' port.(If you connect with 'CAMERA1' port and floor distributor, it will not be operated normally.
- Do not use it with other devices when you use it with floor distributor, other devices,
- When the system power cut off in case of blackout, each device can't be recognized to each other because of communication problem. In this case, re-boot the Video-phone.

※ Note

1. In case, if there is a high-voltage power line in the area of installation, use metal tube coaxial cable for wiring
2. Beware of wrinkling of line coating and cable stick-outs as it may cause circuit shortage and operation inconvenience.
3. When connecting a monitor with a camera, make sure power switch is turned off.



9. Product components

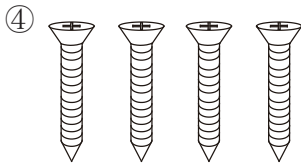
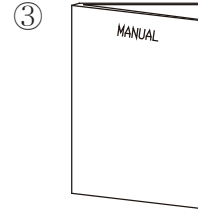
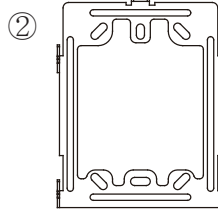
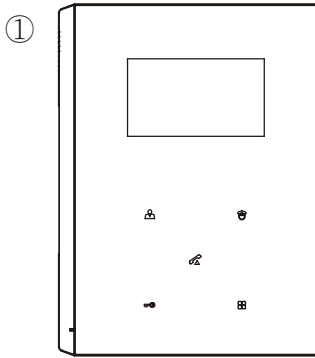

(T)4 X 18mm



(M)3 X 6mm

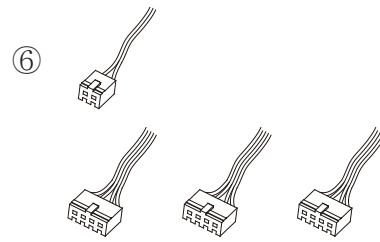

2P(1EA)
4P(3EA)

①	Monitor(CMV-43S)	1EA
②	Wall bracket for monitor	1EA
③	User Manual	1EA
④	Wall bracket mounting screw	4EA
⑤	Monitor fixing screw	1EA
⑥	Connector 2P	1EA
	Connector 4P	3EA



10. Specifications

CMV-43S

Wiring type	Camera 4-wire (Polarity, CAM2 will be convertible with MODUM system) Inperphone 4-wire (Polarity)
Power	100V-240V~, 50/60Hz
Power Consumption	Stand by : 4 W Max : 10 W
Communication method	HANDS FREE type (Voice switch circuit)
Monitor	4.3" TFT-DIGITAL LCD
Ringtone	- Individual entrance: Electronic chime with 3 tones (for 2 consecutive times) - Guard : Melody chime - Interphone : Electronic bell
Image transmitting time	Monitoring : 30 ±5sec , Communication : 60 ±5sec
Max. Distance(UTP)	28m(0.5mm) / 50m(0.65mm) / 70m(0.8mm)
Operating Temperature	0 ~ +40°C (32° F ~ 104° F)



11. Safe Operation guide

- Make sure to turn on the product
- In case if physical damage or operation failure is detected, do not hesitate to contact Service Center
- All electric power must be blocked by the building blocking device
- Do not place water bottles or flowerpots upon the product
- Please, turn the power off when installing or repairing the product

COMMAX

COMMAX Co.,Ltd.

513-11, Sangdaewon-dong, Jungwon-gu, Seongnam-si, Gyeonggi-do, Korea

Int'l Business Dept. Tel. : +82-31-7393-540~550 Fax. : +82-31-745-2133

Web site : www.commax.com

PM5443S00010

Printed In Korea / 2015.03.104