

Since 1968

COMMAX
SmartHome & Security

User Manual

Color video door phone CDV-71UM



www.commax.com

COMMAX Co.,Ltd.



- Thank you for purchasing COMMAX products.
- Please carefully read this User's Guide (in particular, precautions for safety) before using a product and follow instructions to use a product exactly.
- The company is not responsible for any safety accidents caused by abnormal operation of the product.

Greetings









- Thank you for choosing COMMAX.
- Please read this manual carefully before you use the product.

Table of contents

Greetings	1
Contents table	1
1. Warnings and caution	2
2. Part Names	4
3. Function and Description	5
4. GUI Description	10
5. Wiring schematic.....	29
6. Product components	31
7. Caution in use	32
8. Miscellaneous	32
9. Specification.....	32











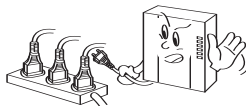

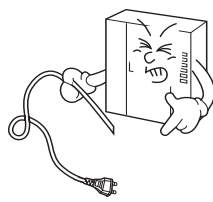



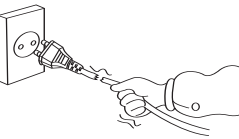

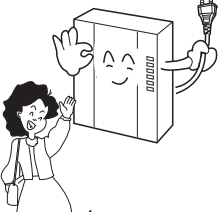

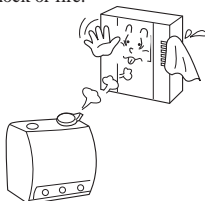

1. Warnings and caution

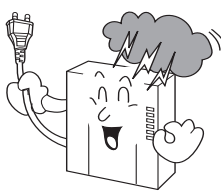
Please follow the things described below in order to prevent any danger or property damage.

 <p>Warning It may cause a serious damage or injury if violated.</p>  <p>Caution It may cause a minor damage or injury if violated.</p>	<ul style="list-style-type: none">  Prohibition.  No disassembly  No touch  Must follow strictly.  Shows plugging out the power cord without an exception  Shows the warning and caution for an electric shock.  Shows the warning and caution for a fire.
---	--

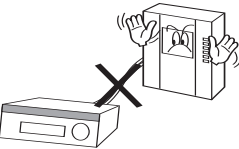
Warning

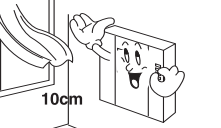
Power & Installation

<p>Please don't use several products at the same time on one power socket. · It may cause a fire due to an abnormal overheating.</p>  <p> </p>	<p>Please don't bend the power cable excessively or it may cause an electric shock. · fire when using a damaged power cable.</p>  <p>  </p>	<p>Please don't handle the power cable with a wet hand. · It may cause an electric shock.</p>  <p> </p>	<p>Please plug out the power cable from the socket when not using it for a long period of time. · It may shorten the product lifespan or cause a fire.</p>  <p> </p>
<p>Please don't install the product in the place where there is much oil, smoke or humidity. · It may cause an electric shock or fire.</p>  <p>  </p>	<p>Please don't install the product with the lightning and thunder. · It may cause an electric shock or fire.</p>  <p>  </p>	<p>Please don't use and connect this product with other products with different rated voltage. · It may cause a disorder or fire.</p>  <p> </p>	<p>When installing the product that generates heat, please install the product away from the wall (10cm) for the ventilation. · It may cause a fire due to the increased internal temperature.</p>  <p> </p>

! Warning

Cleaning & Use

Please don't disassemble, repair or rebuild this product arbitrarily (please contact the service center if a repair is needed).

- It may cause an electric shock or fire.



No disassembly



Electric shock Fire Unplug

If an abnormal sound, burning smell or smoke is coming out of the product, please plug out the power cable and contact a service center.

- It may cause an electric shock or fire.

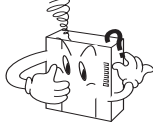

Electric shock Fire

Please don't insert any metallic or burnable materials into the ventilation hole.

- It may cause an electric shock or fire.

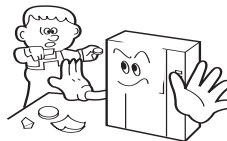

Prohibition Electric shock Fire

Please use only the designated batteries for the products of using DC power.

- It may cause an electric shock or fire.



Request

! Caution

Power & Installation

Please plug the power cable firmly into the inner end

- It may cause a fire.

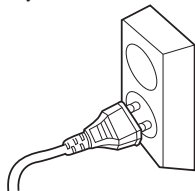

Request Fire

Please hold the plug tightly when unplugging the power cable (a part of the copper wire may be disconnected if the grabbing is only made on the cord when pulling out the cable).

- It may cause an electric shock or fire.



Request Electric shock Fire

When connecting the power cables after cutting the cable, please install the product with power off

- It may cause an electric shock or fire.

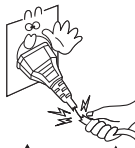

Request Electric shock Fire

When installing the product, please fix it firmly while using the wall-mounting unit and screws.

- It may cause an injury from the falling object.

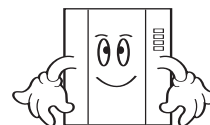

Request

Please be careful when using an AC circuit breaker since there is a possibility of an electric shock.

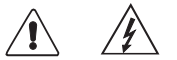
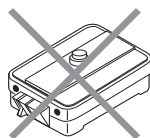

Request Electric shock

Please check the use voltage and current for the DC-only products and use the appropriate rectifier.

- It may cause a fire.

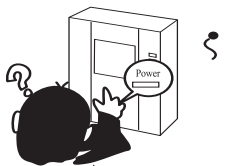

Request Fire

Please avoid direct rays of the sun or heating devices at a time of installation.

- It may cause a fire.

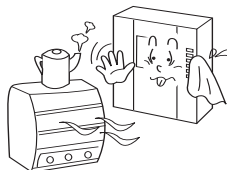

Request Overheating Fire

Please don't install the product on an unstable place or small support board.

- It may cause an injury if it falls down while in use.

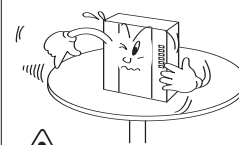

Request

Cleaning & Use

When cleaning the product, please rub it with a soft and dry cloth after plugging out the power cable. (Please don't use any chemical products such as wax, benzene, alcohol or cleanser.)



Prohibition

Please don't drop the product on the ground and don't apply a shock.

- It may cause a failure.

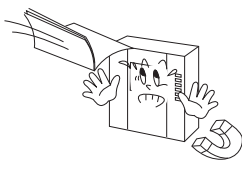

Prohibition

Please use the designated connection cable within the maximum calling distance designated for the product

- It may reduce the product performance.

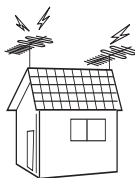

Request



2. Part Names

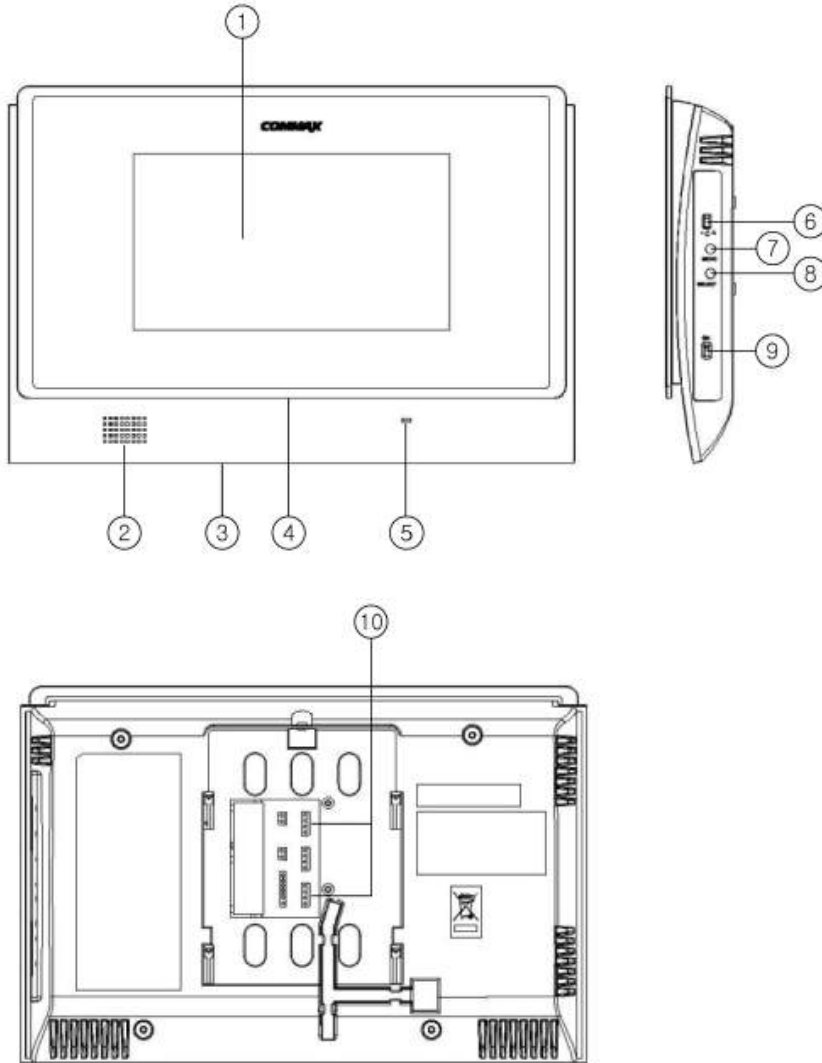

No.	Description	No.	Description
1	LCD Touch Screen	6	Volume control
2	Speaker	7	Talk button
3	SD Card Slot	8	Door release button
4	Power lamp	9	Power switch
5	Microphone	10	Connecting terminal

- This videophone product provides different functionality for connecting the second door camera. At the time of booting, the built-in program checks the connectivity of the second door camera and commands to supply the power to the second camera.
- Therefore, in case of connecting the second camera, the connection must be completed before the power is turned on.
- This product provides a full touch feature.
All functions are operated by touch of icons displayed on screen.









3. Function and Description

Stand-by mode

- As power is turned on by power switch, the blue LED located at the bottom of the front panel is turned on and the booting logo is displayed. After a few seconds, you will hear the beep tone and the videophone is now in standby mode.

Main menu

(1) Page and Call function



- As the paging button on a door camera is pressed, the paging tone ("Sol-Mi-Do") rings at the connected videophone and sub-interphone (if connected to the videophone) for two times consecutively. The door camera view is displayed on the videophone within 3 seconds and the blue LED at the bottom of the screen starts blinking.
- Touch "  " icon to talk to the visitor. The LCD screen of the videophone will remain on for 30 seconds if not answered. If answered, it will remain on for 60 seconds.
- The "  " icon is displayed on the screen. To answer a call from door camera, simply touch the "  " icon.
- To page an interphone connected to the videophone from Home screen, simply touch the "  " icon. The "  " icon is displayed on the screen at the bottom right of the screen and touch the icon again to page the interphone. To answer a call, paged from the videophone, simply pick up the handset. To end a call from the videophone, touch the interphone icon "  "
- To call the videophone from the interphone, simply pick up the handset and keep pressing the paging button. If the icon is released, it stops paging the videophone. **Please keep pressing the button until answered from the videophone.** The paging tone rings at the videophone and to answer the call, paged from the interphone, touch "  " icon to answer the call. The interphone icon on the screen remains for 10 seconds after the call is ended and the videophone enters standby mode.

(2) Ringtone volume control (low → high)

- Ringtone volume is controlled by the switch located on the right side of the panel.

(3) Call function

- Touch a camera icon to answer the call. The blue LED at the bottom of the panel blinks. If the handset of the interphone connected to the videophone is picked up during the call between the videophone and the door camera, 3-way call is enabled.
- Talk time is limited to 60 seconds and will automatically be ended.

- If the "  " icon is touched during a call from a videophone to a door camera, the handset of the interphone can be picked up to enable 3-way call.
 - If a visitor presses a paging button from the door camera 2 during a call between the videophone and the door camera 1, the first call from the door camera 1 is ended and the connection to the door camera 2 is made automatically.
 - If a visitor pages the videophone from a door camera during a call between the videophone and the sub-interphone in progress, the door camera view is displayed on the videophone and the 3-way call is enabled.
- ※ All calls are ended if the "  " icon is touched during the call.

(4) Recording video

- When paged from a door camera or monitoring the door camera view from the videophone, touch the "  " icon to record the video.
- In case of recording still images, it is taken every time the icon is touched.
- While recording a video, the recording continues.
- This function is enabled regardless of the settings of "Automatic Saving/Manual Saving" in the settings menu.
- This function is enabled even during a call between the videophone and the door camera.
- The video and still images are recorded on to SD Card memory and without the SD Card memory inserted in the videophone, video and still images cannot be recorded.

(5) Monitoring

- By touching the camera icon from the videophone, the camera view is monitored from the videophone screen.
- If you continue monitoring other cameras connected to the videophone, please touch the icon located on the upper left corner of the display. The cameras in the following order will be displayed on the screen (CAM1 → CCTV1 → CAM2 → CCTV2 → ... → Continue in loop)
- To end monitoring, simply touch the exit icon "  ".

(6) Door release

- To open the door, simply touch the "  " icon on the screen.

(7) Still image recording function

- ※ This function is activated when the settings is set to record still images.
- If set as "Auto Saving", the still image is recorded every time paged from a door camera.
- During monitoring or talking with the door camera, touch the "  " icon to record the still image

(8) Video recording function

- This function is activated when the settings is set to record video.

If set as "Automatic Saving", the video is recorded every time paged from a door camera.

When paged, recorded for 30 seconds and when talking, recorded for 60 seconds.

The maximum recorded time is 90 seconds (30 seconds when paged + 60 seconds when answered)

- ※ **Caution 1 : Do not remove SD Card while recording still images or video. It may damage the SD Card and data can be lost.**
- ※ **Caution 2 : This product records only on to SD Card and without the SD Card inserted or with damaged SD Card, still images and video cannot be recorded.**

Managing Folder and File

- Root folders created
 - . \MOVIE
 - . \PICTURE

If below icon is displayed on the screen, please backup the data.

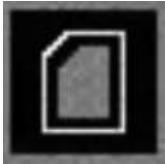

⇒ Recorded file name and format

Still image	000001C1.jpg			
	000002C2.jpg			
	000003D1.jpg			
	000004D1.jpg			
Video	000001C1.asf			
	000002C2.asf			
	000003D1.asf			
	000004D2.asf			
Description	Date	Time	Video Type	File Type
	2014-10-25 (YY-MM-DD)	13:05:02 (13H5M2S)	C1,C2: Door 1,2 (Still Image) D1,D2: CCTV 1,2 (Video) C1,C2 : Door 1,2(Still Image) D1,D24 : CCTV1,2(Video)	Still Image → (*.jpg) Video → (*.asf)
Note	<p>⇒ SD Card requires a minimum space availability for system operation. Minimum storage space: Min. 300MB.</p> <p>⇒ Still image recorded up to 256 cuts. As it becomes full (256 cuts), overwrites from the oldest data.</p> <p>⇒ Video is recorded up to maximum space availability of the SD Card. If no space available on the SD Card,</p> <div style="display: flex; align-items: flex-start;">  <p>Backup icon is displayed on the screen. As the above icon is displayed, it starts to overwrite from the oldest data. At this time, several files can be deleted to keep minimum space availability for system file. It is strongly recommended to backup important video data. Depending on the SD Card memory, number of files to be recorded may Vary. Please refer to below table. Even if the CD Card memory has space available, it starts to overwrite as the number of file limit exceeds.</p> </div> <p>⇒ a single file or all files may be selected to delete.</p>			

⇒ Limit of files for various SD Card size

	SDHC Card		
Size	4 GByte	8 GByte	16 GByte
Still Images	256	256	156
Limit of Video Files (60 Second long)	max 380	max 750	max 1,500
Recording time	Appx. 380 min	Appx. 750 min	Appx. 1,500 min

4. GUI Description

(1) As Powered On

As powered on, the "COMMAX" booting logo is displayed and the system checks SD Card memory availability. The SD Card icon "___" is displayed and the message, "SD CARD CHECKING..." is displayed on the screen. As the system initializing is completed, a beep sounds and the screen becomes off to enter standby mode.







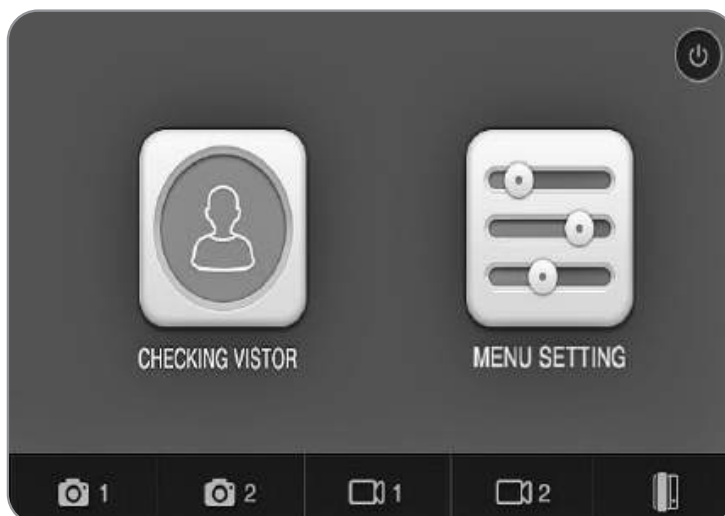

(2) Main menu

In standby mode (screen is off), touch the screen to turn on the screen.

To go back to standby mode, touch the power icon () located on the upper right corner of the screen.



Icons and description





Icon	Description	Function
	Checking Visitor	Check recorded video or still images of visitors.
	Menu Settings	Setup functions.
	Camera_1	Call or monitor the Door Camera_1.
	Camera_2	Call or monitor the Door Camera_2.
	CCTV_1	Monitor CCTV Camera_1 view.
	CCTV_2	Monitor CCTV Camera_2 view.
	Interphone	To call the sub-interphone.

(3) Checking Visitor

Select video or still image.





Icons and description

Icon	Description	Function
	Video	Check visitors of recorded video.
	Still Image	Check visitors of still images.
	Home	Return to main menu.
	Prev	Move to previous menu.

Recorded videos and still images are listed in 4 split screen in chronological order with time.



Icons and description





Icon	Description	Function
	Prev	Move to previous menu or screen.
	UP	Move to previous page.
	DOWN	Move to next page.

(4) Check video

As a single video is selected from the 4 split screen, the screen turns to full screen to playback the selected video. To delete the video, touch  icon.



Icons and description





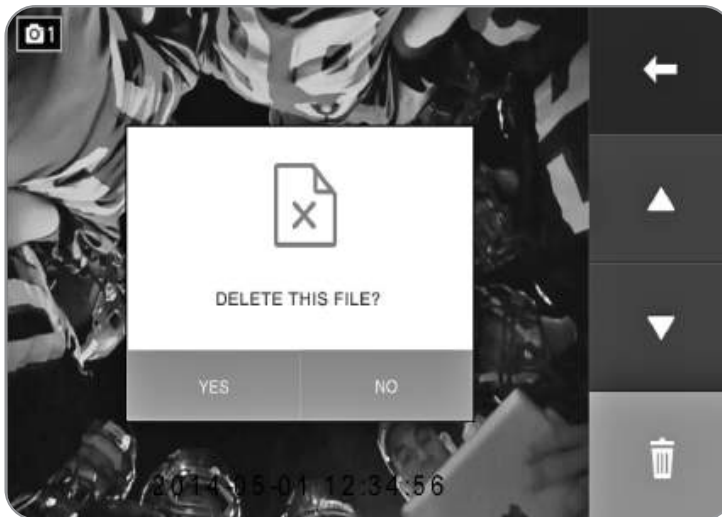

Icon	Description	Function
	Prev	Move to previous menu or screen.
	UP	Move to previous page.
	DOWN	Move to next page.
	Delete	Delete the selected video.

(5) Delete recorded video

Touch  icon to delete the video. Touch "Yes" to delete.



Icons and description







Icon	Description	Function
	Prev	Move to previous menu or screen.
	UP	Move to previous page.
	DOWN	Move to next page.
	Delete	Delete the selected video.
	Yes	Command to delete.
	No	Cancel delete.

(6) Settings

Time, display, and language setup are enabled in Settings menu.



Icons and description







Icon	Description	Function
	Time Setting	Date and time setup.
	Display Setting	Display setup for contrast, brightness, hue.
	Language Setting	Language setup (8 languages supported)
	Setting (More)	Settings menu for other functions.
	Home	Return to main menu.
	Prev	Move to previous menu or screen.

(7) Time

The time stamp for recorded video and still images are recorded according to time setup in this menu. The year, month, date, hour and minute can be adjusted by left and right button. Touch the category to adjust. Touch  icon to complete the setup.



Icons and description

Icon	Description	Function
	Decrease value	Decrease the time and date to adjust.
	Increase value	Increase the time and date to adjust.
	Save	Save the date/time settings.
	Cancel	Cancel the date/time settings.
	Home	Return to main menu.
	Prev	Move to previous menu or screen.

[CAUTION]

The time and date automatically reset if powered off for 48 hours. Time and date settings required as powered on.

(8) Display

Brightness, contrast, and hue can be set in this menu.

Touch the category that you wish to adjust.

Touch " + " or " - " Icon to change the value.

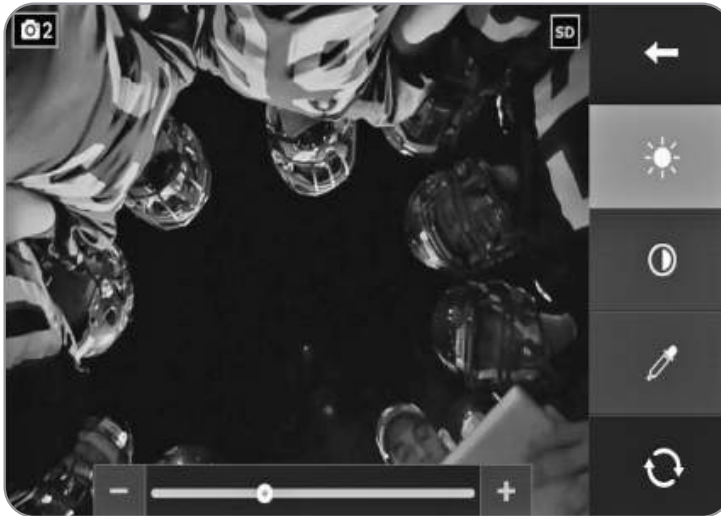

Icons and description

Icon	Description	Function
	BRIGHTNESS	Adjust the brightness.
	CONTRAS	Adjust the contrast.
	HUE	Adjust the color.
	Reset	All values are reset to default settings (Brightness, Contrast, Hue reset to the middle).
	Prev	Move to previous menu or screen.





(9) Language

Language setup is enabled in this menu (Default language settings is English).

Select the language you wish to set and touch  to complete the settings.



Icons and description







Icon	Description	Function
	Save	Save the language settings.
	Cancel	Cancel the language settings.
	Home	Return to main menu.
	Prev	Move to previous menu or screen.

(10) More (settings for other functions)

Settings for Saving Method (video or still image), Reset All Settings, Automatic/Manual Saving, and Motion detection (of CCTV camera) is enabled in this menu.



Icons and description

Icon	Description	Function
	Saving Method	Recording option setup. (Video / Still image)
	All Initialization (Reset All Settings)	All settings of the device including recorded video and still image data are to be reset and deleted.
	Automatic/Manual Saving	Select recording option from Automatic and Manual.
	Motion	Settings for motion detection option of CCTV cameras connected to the videophone.
	Home	Return to main menu.
	Prev	Move to previous menu or screen.

(11) Saving Method





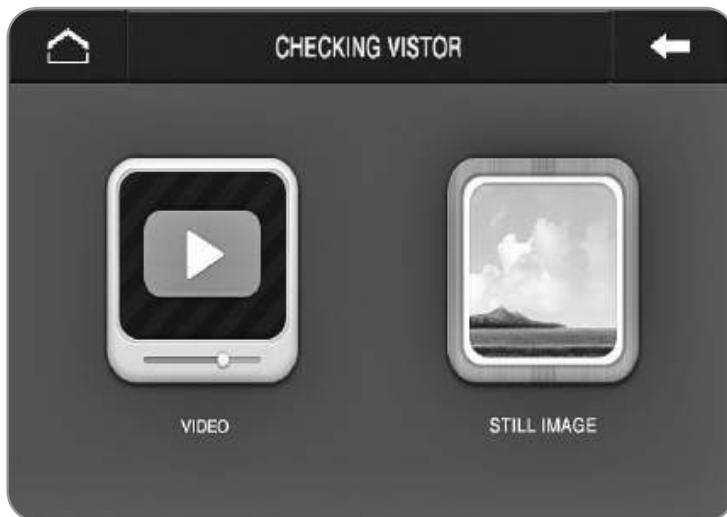

Recording option can be selected between video and still image.

If video is selected, video is recorded and audio is also recorded for door camera recording. CCTV camera recording is only for video.

If still image is selected, only the still image is recorded.



Icons and description

Icon	Description	Function
	Video	If selected, video is recorded(both video & audio recording is for door camera recording.)
	Still Image	If selected, still images are recorded.
	Save	Save video or still image depending on the recording option.
	Cancel	Cancel recording option settings.
	Home	Return to main menu.
	Prev	Move to previous menu or screen.

(12) Reset All Settings



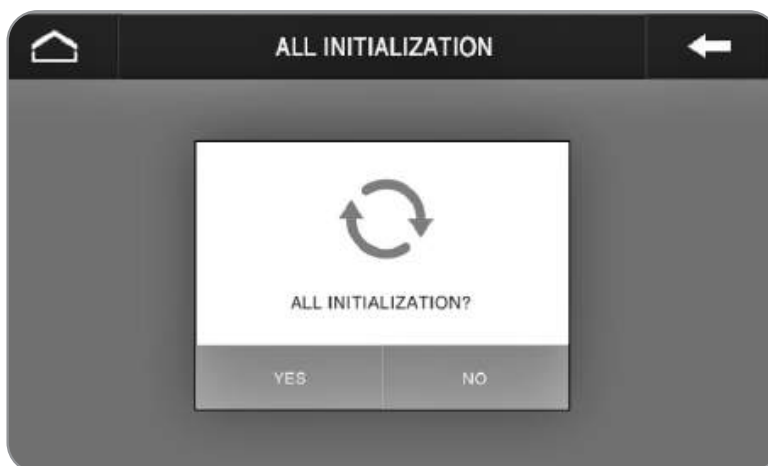

This function resets all settings of the device to initial settings and inserted SD Card memory is formatted. All the recorded video and still images on the SD Card are completely deleted if "Reset All Settings" function is performed with the SD Card memory inserted in the device. We strongly recommend to backup the recorded video and still images or remove the SD Card memory prior to performing the reset function.

Time settings remains however, the time is reset if powered off for 48 hours.

- Please backup the recorded video and still images or remove the SD Card from the device prior to perform "Reset All Settings" function.



Icons and description

Icon	Description	Function
	All Initialization (Reset All Settings)	All settings of the device is set to initial settings and the inserted SD Card is formatted (Time and Language settings remain).
	Yes	Start reset all settings.
	No	Cancel reset all settings.
	Home	Return to main menu.
	Prev	Move to previous menu or screen.

(13) Automatic/Manual Saving

This function is to select Automatic or Manual Saving option.



Icons and description

Icon	Description	Function
	Automatic Saving	Set recording option to automatic.
	Manual Saving	Set recording option to manual.
	Save	Save Automatic/Manual Saving option settings.
	Cancel	Cancel Automatic/Manual Saving option settings.
	Home	Return to main menu.
	Prev	Move to previous menu or screen.

(14) MOTION Detection (including the sensitivity settings)

The motion detection recording option of CCTV camera and its sensitivity can be set (Ref. Only one camera is recorded at a time and motion detection function applies to one camera as well. When door camera button is pressed while the CCTV camera motion detection recording is on, the recording channel is instantly changed to door camera from the CCTV camera).

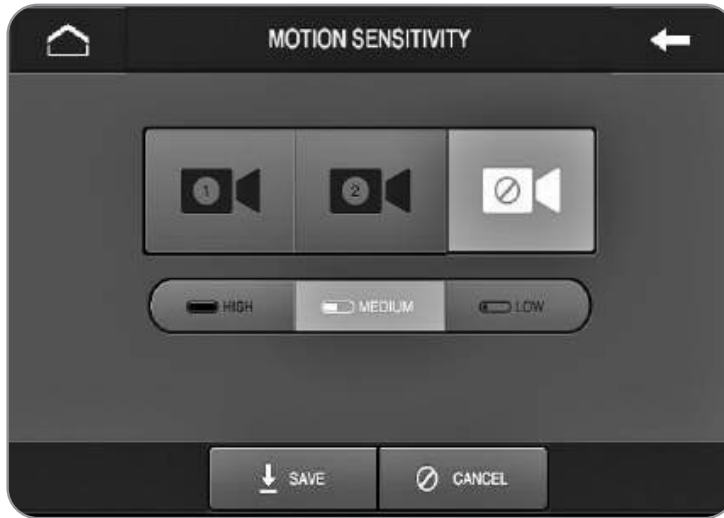



Icons and description



Icon	Description	Function
	CCTV_1	Touch this icon and activate CCTV_1 for motion detection recording.
	CCTV_2	Touch this icon and activate CCTV_2 for motion detection recording.
	MOTION Not Activated	MOTION detection is not activated.
	High	Cancel Automatic/Manual Saving option settings.
	Medium	Return to main menu.
	Low	Move to previous menu or screen.
	Home	Return to main menu.
	Prev	Move to previous menu or screen.



(15) Page, Call, and Door release

When paged from a door camera or the visitor icon  is touched, the door camera view is displayed on the LCD screen.



As the door camera view is displayed on the screen, touch the call icon  to connect to the door phone.

- The camera icon  located on the upper left corner of the screen indicates which camera view is displayed.

-  icon for still image recording mode or  icon for video recording mode is displayed on the upper right corner of the screen.



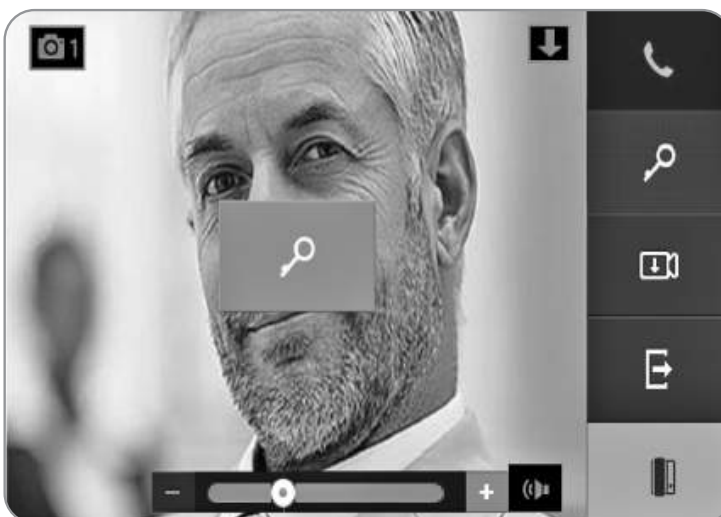

- Touch  or  next to  to control the call volume during a call.

Touch the call icon  to end a call.

Touch the door release icon  during a call to release the door lock. The blue door release icon  is displayed in the center of the screen and the door is released.



Icons and description

Icon	Description	Function
	Call	To start a call or end a call.
	Door release	Touch to release a door lock during a call.
	Manual Saving	Record video or still images manually by touching the icon during a call.
	Reject call (Exit)	Reject a call when paged from a door camera(video and ringtone become off and enter standby mode) or Exit from current menu.
	Interphone	Page the sub-interphone connected to the videophone.

(16) Interphone

To page an interphone connected to the videophone

In standby mode, touch the interphone icon  to turn the touch screen to interphone mode.

Touch the interphone call icon  to make a call to an interphone.

(when you page the interphone, you need to keep touching the icon).**

As the handset of the interphone is picked up, the call is made.

The call time is limited to 60 seconds.

If the interphone icon  is not touched after 15 seconds, the call is ended and the videophone enters standby mode.



When paged from the interphone

Ringtone sounds and the display is turned to the interphone call screen.

Touch the call icon  to connect.



The call time is limited to 60 seconds.

If the interphone is not answered within 10 seconds, the videophone automatically enters standby mode.

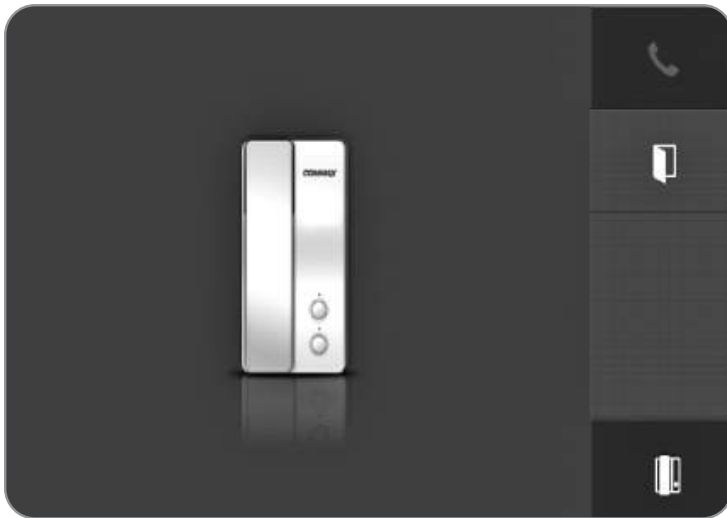
Touch the call icon  to end a call.



Icons and description

Icon	Description	Function
	Call	Start or end a call.
	Reject (Exit)	Reject a call from an interphone (screen and ringtone are off and enter standby mode) or Exit from current menu
	Intephone	Page an interphone.

5. Wiring schematic

Camera connecting terminal (4 wires with polarity)

1. RED: Voice signal input
2. BLUE: GND
3. YELLOW: Power (+12V)
4. WHITE: Video signal input

Sensor connecting terminal (3 wires with polarity)

1. RED: Power (+12V)
2. BLUE: GND
3. YELLOW: SENSOR Signal input

CCTV Connector (2 wires with polarity)

1. RED: Video signal input
2. BLUE: GND

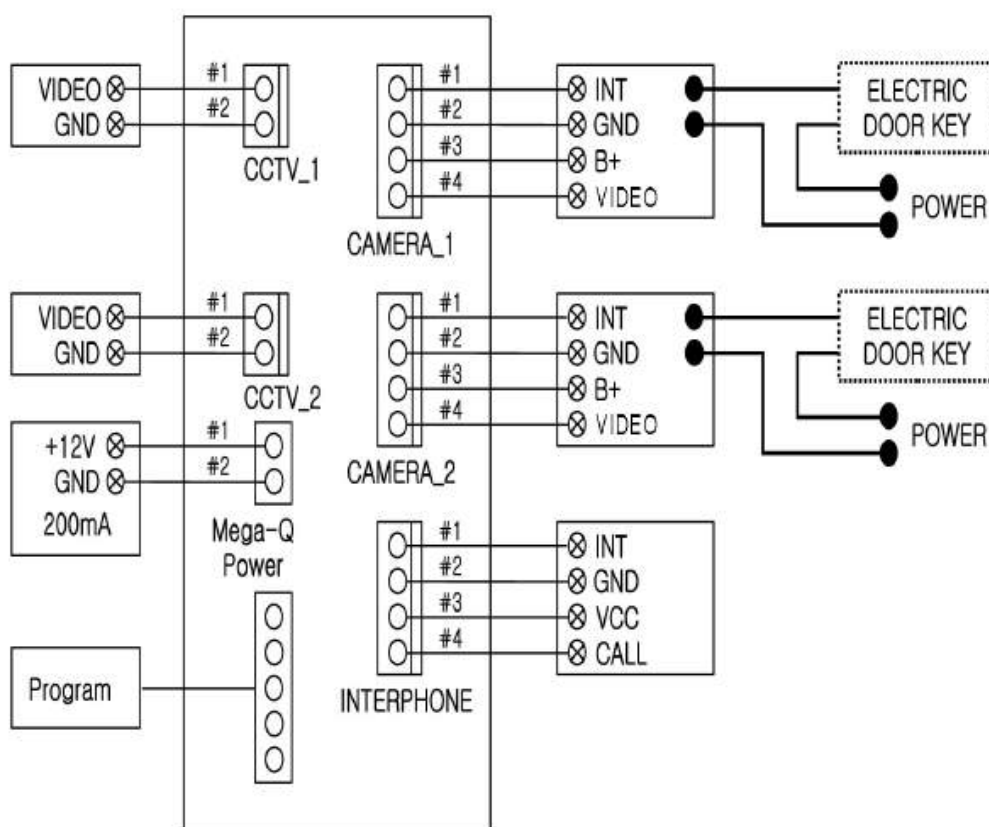

CCTV Camera wiring

- ♠ CCTV CAMERA requires a separate power supply.
- ♠ Use the proper cable (Coaxial Cable) with appropriate specification for various distances between the CCTV CAMERA and the videophone.

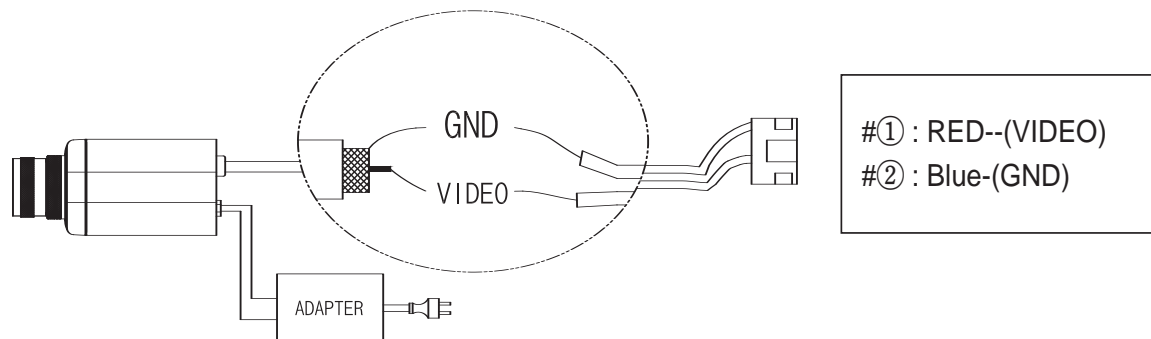

6. Product components

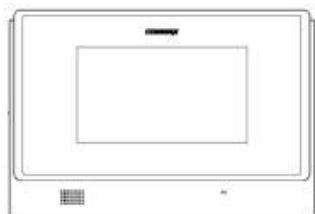

Monitor(CDV-71UM)

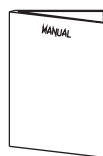

User Manual

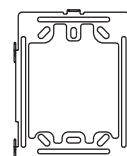

Wall Bracket

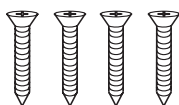

Mounting screw
(4EA)



Monitor fixing Screw
(1EA)

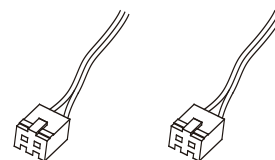

CCTV Camera Connector
(2PX2EA)

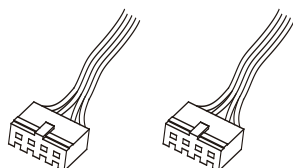

Door Camera Connector
(4PX2EA)

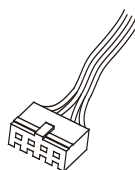

InterPhone Connector
(4PX1EA)

7. Caution in use

1. Turn on the power switch.
2. Please contact your local agent for product maintenance when you have a problem in use of CDV-71UM
3. For your safety, power switch with a safety device must be used in your building.
4. Unplug before installing or repairing the product.
5. Unplug when you connect monitor with door cameras.

8. Miscellaneous

- Please carefully read this User's Guide before calling service man
After checking the entire check list, please contact customer service center.
We will do our best to make you satisfy with our services.

9. Specification

MODEL	CDV-71UM		
Wiring	Door camera 4 wires (Polarity), CCTV 2wires(Polarity), Interphone 4wires(Polarity)		
Voltage	100-240V~, 50/60 Hz		
Power Consumption	Standby : 4.6W , in operation : 16W		
Communication	Full duplex (Hands-Set)		
Monitor	17.78Cm(7") TFT-DIGITAL LCD		
Ringling	- Entrance : Electronic chime (3 call 2times) - Interphone : Electron buzzer		
Video receiving period	Standby : 30 ±5sec , response : 60 ±5sec		
Distance	0.5mm	0.65mm	0.8mm
	28m	50m	70m
Temperature	0 ~ +40°C (32°F ~ 104°F)		
Dimensions(mm)	276(W) X 178(H) X 31(D)		

COMMAX

COMMAX Co.,Ltd.

513-11, Sangdaewon-dong, Jungwon-gu, Seongnam-si, Gyeonggi-do, Korea

Int'l Business Dept. Tel. : +82-31-7393-540~550 Fax. : +82-31-745-2133

Web site : www.commax.com

PM0771UM0010

Printed In Korea / 2014.05.104