

Since 1968

COMMAX
SmartHome & Security

CDV-70M User Manual

FINE VIEW MONITOR



www.commax.com

COMMAX Co.,Ltd.











- Thank you for purchasing COMMAX products.
- Please carefully read this User's Guide (in particular, precautions for safety) before using a product and follow instructions to use a product exactly.
- The company is not responsible for any safety accidents caused by abnormal operation of the product.

Table of Contents











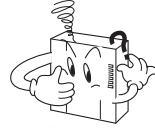

1. Warnings and Cautions	2
2. Part Names and Functions	3
3. Package Contents	3
4. Wiring and Connection Instructions	4
5. Installation	4
6. Operation	5
7. Settings	6
8. Initialization	7
9. Specification	7

1. Warnings and caution

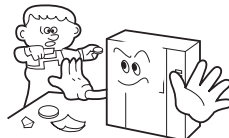
Please follow the things described below in order to prevent any danger or property damage.

 Warning It may cause a serious damage or injury if violated.  Caution It may cause a minor damage or injury if violated.	<ul style="list-style-type: none">  Prohibition.  No disassembly  No touch  Must follow strictly.  Shows plugging out the power cord without an exception  Shows the warning and caution for an electric shock.  Shows the warning and caution for a fire.
---	---

Warning & Caution

Cleaning & Use	<p>Please don't disassemble, repair or rebuild this product arbitrarily (please contact the service center if a repair is needed).</p> <ul style="list-style-type: none"> It may cause an electric shock or fire.      Electric shock Fire Unplug	<p>If an abnormal sound, burning smell or smoke is coming out of the product, please plug out the power cable and contact a service center.</p> <ul style="list-style-type: none"> It may cause an electric shock or fire.    Electric shock Fire	<p>Please don't insert any metallic or burnable materials into the ventilation hole.</p> <ul style="list-style-type: none"> It may cause an electric shock or fire.     Prohibition Electric shock Fire	<p>When cleaning the product, please rub it with a soft and dry cloth after plugging out the power cable. (Please don't use any chemical products such as wax, benzene, alcohol or cleanser.)</p>   Prohibition
---------------------------	---	--	--	---

⚠ Warning & Caution

Power & Installation

Please don't use several products at the same time on one power socket.
 · It may cause a fire due to an abnormal overheating.

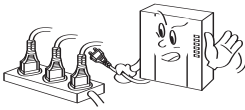

Please don't bend the power cable excessively or it may cause an electric shock.
 · fire when using a damaged power cable.

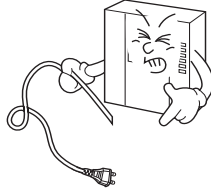

Please don't handle the power cable with a wet hand.
 · It may cause an electric shock.

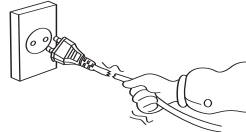

Please plug out the power cable from the socket when not using it for a long period of time.
 · It may shorten the product lifespan or cause a fire.

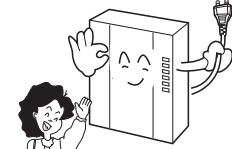

Please don't install the product in the place where there is much oil, smoke or humidity.
 · It may cause an electric shock or fire.

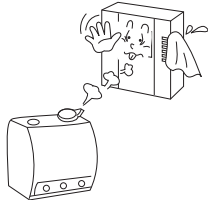

Please don't install the product with the lightning and thunder.
 · It may cause an electric shock or fire.

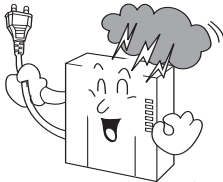

Please don't use and connect this product with other products with different rated voltage.
 · It may cause a disorder or fire.

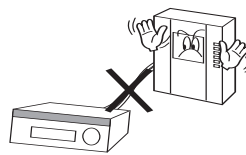

When installing the product that generates heat, please install the product away from the wall (10cm) for the ventilation.
 · It may cause a fire due to the increased internal temperature.

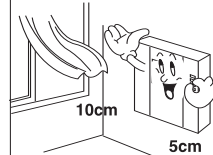

2. Parts Names

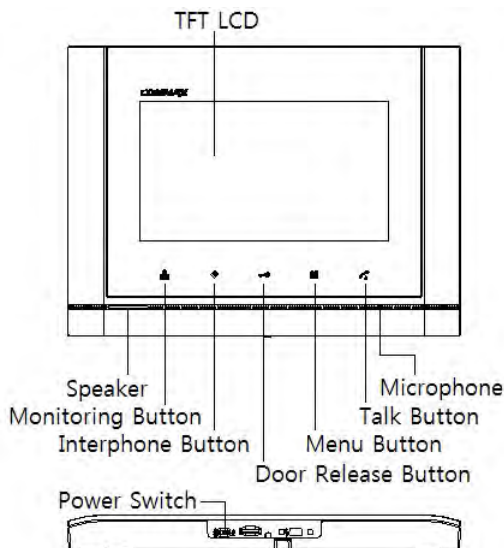

3. Contents

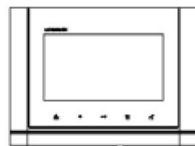

Video Phone (CDV-70M)

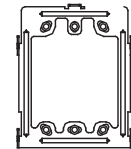

Wall bracket for monitor (1EA)



User Manual (1EA)



Camera connector (CONN. 4P*200) (2EA)

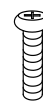

Monitor fixing Screw (PHM 3*6 ZnY)

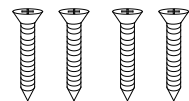

Screw for wall bracket (Screw GH1T 4*18 ZnY)

4. Wiring and Connection Instructions

▷ Polarity of the camera connector

1. Red: Talk (Audio)
2. Blue: GND
3. Yellow: Power (+12V)
4. White: Video

▷ Polarity of interphone connector

1. Red: Talk (Audio)
2. Blue: GND
3. Yellow: Power (+14V)
4. White: Call signal

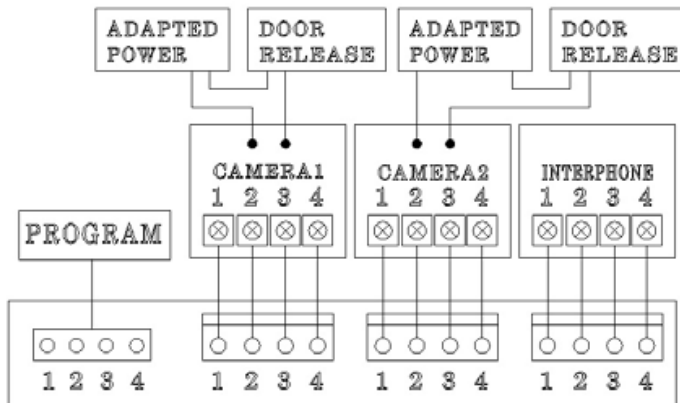

* Each device should be connected by separated cables.
If you use UTP CABLE[CAT.5] for CAMERA1 and CAMERA2, 2 lines of UTP cable are required.

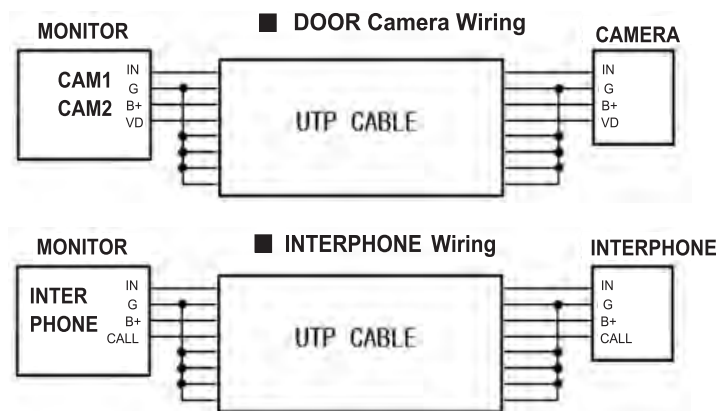

5. Installation

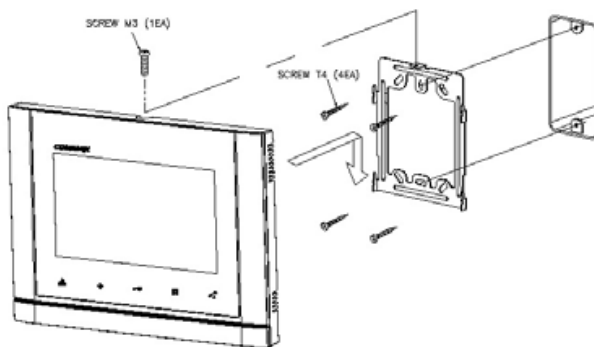

⚠ Cautions

- ① Avoid the direct sunlight.
- ② Recommended height is around 1450~1500mm
- ③ Avoid the installation near magnetic activity, humid temperature and gas.

6. Operation

1. Calling of visitor

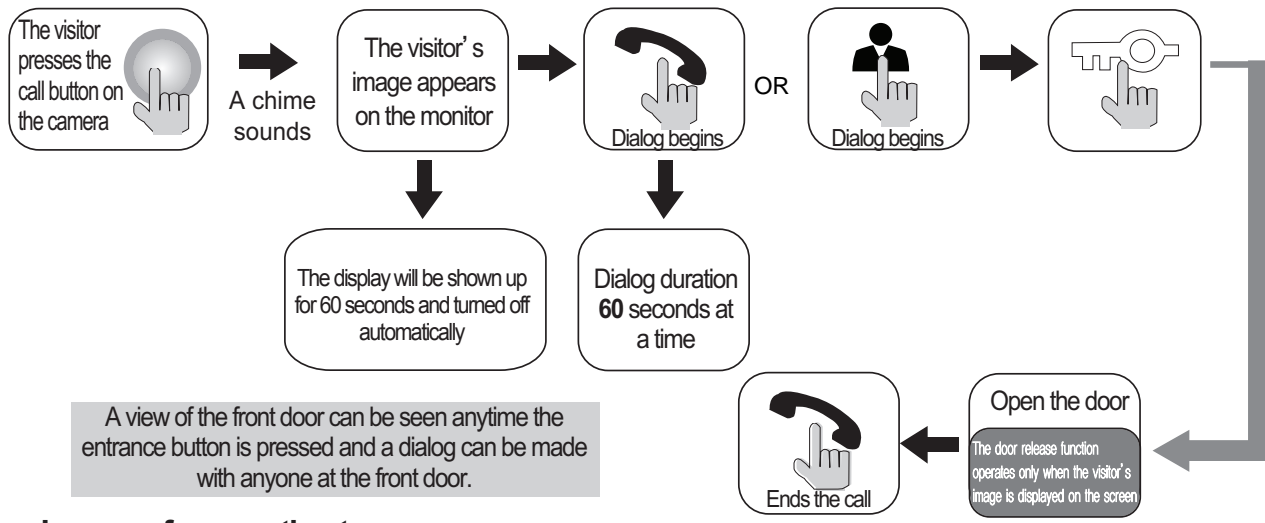

* In case of connecting two cameras

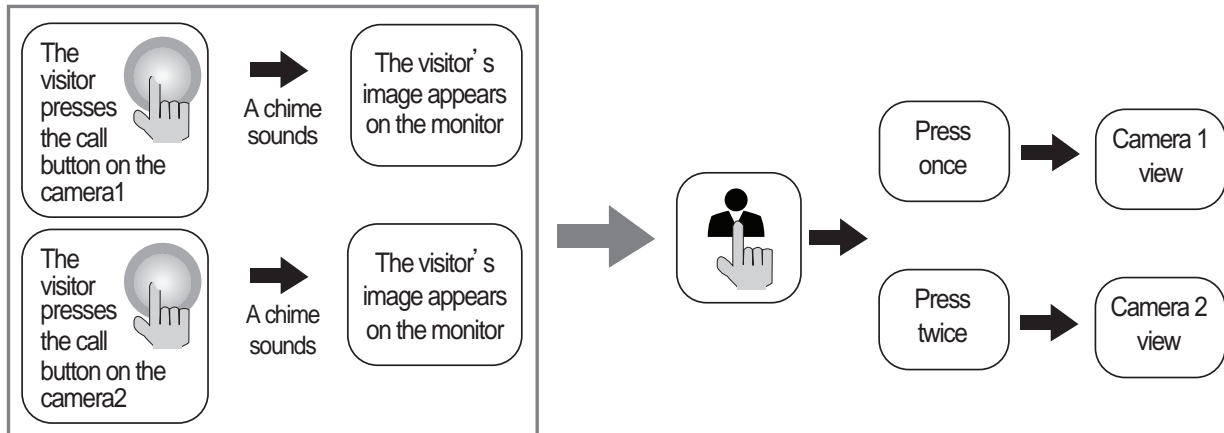

2. Communication with the optional Interphone

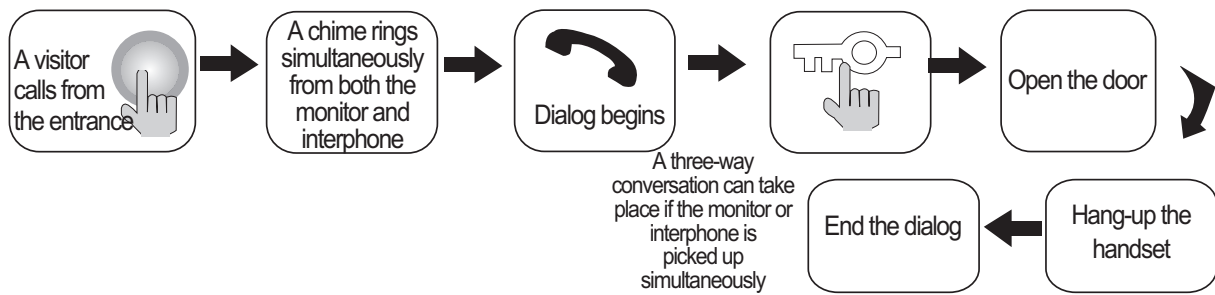

Dialog between the interphone and camera is possible only when the visitor's image is visible on the monitor screen.

7. Settings

After Menu screen appears, you can change setting with below 4 buttons

Menu start and finish : [] (Menu button - [])

SELECT : [] (Interphone button - [])

Move upward /move right : [] (Door release button - [] / [])

Move downward /move left : [] (Monitoring button - [] / [])

After pressing MENU button in Video call or monitoring mode, you can change settings for DOOR VIDEO SET (BRIGHTNESS / CONTRAST/ COLOR), UTILITY (ADDITIONAL FUNCTION) and INFORMATION (product information)

4-1. Screen setting (Brightness/Contrast/Color adjustment function)

Press the MENU button and access to DOOR VIDEO SET and enter the setting menu by pressing the SELECT button.

- (1) BRIGHTNESS: Adjusting Brightness of Screen.
- (2) CONTRAST: Adjusting Contrast of Screen.
- (3) COLOR: Adjusting Color of Screen.

You can control from 0 to 20 level. Initial level is set for level 10

※ how to set

After moving to menu with your desired MENU from 'DOOR VIDEO SET', press SELECT button to move to the menu below

- (4) RESET: reset display setting

※ how to set

After moving to RESET from DOOR VIDEO SET, press SELECT button for RESET.

Select YES with move button.

Complete your setting by pressing SELECT button

- (5) EXIT : Go back to setting mode

4-2. UTILITY (additional function)

Press the MENU button and access to UTILITY and enter the menu by pressing the SELECT button.

- (1) SPEAKER-VOLUME: setting receiver sound level .

There are 3 levels of volume control options and default is level 2

※ how to set

After moving to SPEAKER VOLUME from UTILITY, press SELECT button for SPEAKER VOLUME.

Select your desired setting.

Complete your setting by pressing SELECT button

- (2) CHIME-BELL VOLUME : setting call sound level.

You can control from 0 (MUTE) to 3 level. Initial level is set for level 2.

※ how to set

After moving to CHIME-BELL VOLUME from UTILITY, press SELECT button for CHIME-BELL VOLUME.

Select your desired setting.

Complete your setting by pressing SELECT button.

(3) SCREEN MODE : to set for screen ratio.

*** How to adjust**

※ how to set

After moving to SCREEN MODE from UTILITY, press SELECT button for SCREEN MODE.

With ▲/▼ button, select your desired setting.

Complete your setting by pressing SELECT button.

♣ ZOOM :4:3 display is changed into full display mode (default)

♣ 4:3 : actual ratio of camera.

♣ WIDE : display is changed into 16:9 display mode

(4) EXIT: Go back to the UTILITY Setting menu.

4-3. INFORMATION (The function to check Model name & Version)

In order to check the product information, Press the menu button and move to INFORMATION menu with UP/DOWN button.

(1) MODEL : You can check the model name.

(2) VERSION : You can check the model version.

(3) SYSTEM : SINGLE (FINE VIEW VIDEOPHONE)

(4) TOUCH : You can check the touch-key version.

(5) VIDEO : You can check the video transmission formats(NTSC/PAL)

(6) SOURCE : You can check the position of camera(DOOR1 / DOOR2) which is shown on the screen for now.

4-4. EXIT (Finish setting menu)

8. Initialization (RESET)

- Press the interphone button and door release button at the same time for about 3 seconds. Then, image setting value and sound volume will be initialized.

9. Specification

SPEC	CDV-70M		
Wiring	Door camera 4wires (Polarity), interphone 4wires (polarity)		
Rating Voltage	CDV-70M : 100-240V~, 50/60Hz(FREE VOLTAGE)		
Power consumption	Stand-by : 3 W	Maximum: 15 W	
Transmission way	HANDS FREE (Voice switch circuit)		
Screen size	7" TFT-DIGITAL LCD		
Ringtone	Door : Electronic chime (Sol Mi Do), Interphone : Beep		
Display	Monitoring : 30 ±5sec		Talk : 60 ±5sec
Distance(Cable thickness)	Pie 0.5mm	0.65mm	0.8mm
	28m	50m	70m
Working temperature	0 ~ +40°C (32°F ~ 104°F)		

COMMAX

COMMAX Co.,Ltd.

513-11, Sangdaewon-dong, Jungwon-gu, Seongnam-si, Gyeonggi-do, Korea

Int'l Business Dept. Tel. : +82-31-7393-540~550 Fax. : +82-31-745-2133

Web site : www.commax.com

PM0770H20010

Printed In Korea / 2016.11.104